

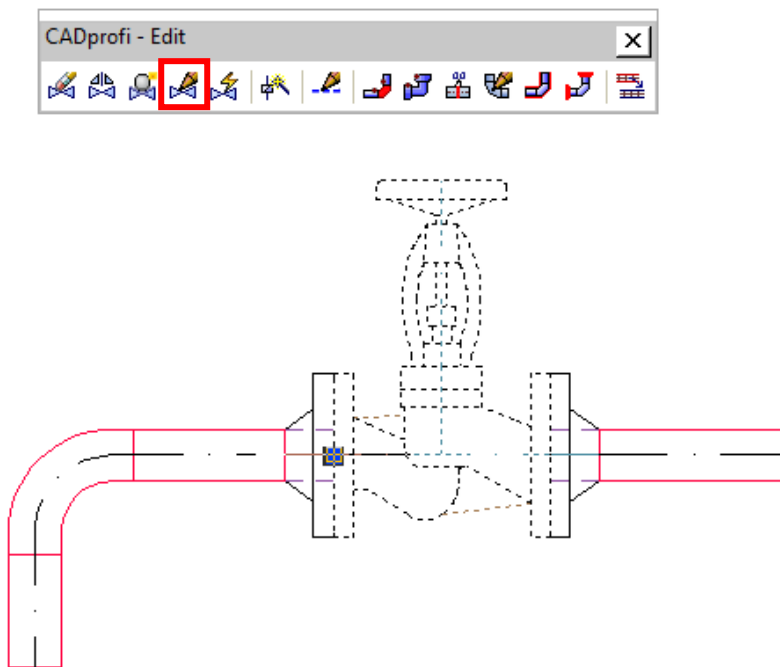

CADprofi 2021.11

✓ CADprofi – editing parametric objects

The new version of the program allows user to freely edit parametric objects using the *Edit*  command.



Parametrical armature

Flange armature

- Stop valve
- The ball valve between the flange
- Ball valve flanged
- Ball valve flanged
- Ball valve flanged with rotary-piston
- Flanged valve with actuator
- Butterfly valve between the flange
- Butterfly valve between the flange
- Damper
- Gate valve
- Reducing valve
- Knife gate valve
- Check valve between the flange
- Check valve flanged
- Check valve between the flange
- Check valve flanged (oblique)
- Ball-check valve
- Swing check valve
- Filter flanged
- Amortising fitting flanged
- Reduced coupling
- Plate silencing between the flanged
- Controllable anti-pollution check valve
- Gas pressure regulator
- Three-way mixing valve

Name	L	H	C	B	PN	Manufact
PN16						
DN15	130	190.0	95	16	PN16	
DN20	150	190.0	105	18	PN16	
DN25	160	210.0	115	18	PN16	
DN32	180	215.0	140	18	PN16	
DN40	200	250.0	150	18	PN16	
DN50	230	255.0	165	18	PN16	
DN65	290	285.0	185	18	PN16	
DN80	310	350.0	200	20	PN16	
DN100	350	410.0	220	20	PN16	
DN125	400	460.0	250	22	PN16	
DN150	480	520.0	285	22	PN16	
DN200	600	635.0	340	24	PN16	
DN250	730	755.0	405	26	PN16	
DN300	850	870.0	460	28	PN16	
Gestra - PN6						
Gestra - PN16						
Gestra - PN25						
Gestra - PN40						

View and insertion point

Insertion point: Point 1

System Supply

View 1 View 2 Scheme View 3 Symbol

Start element Neck flanges

End element Neck flanges

Insert reducer

Repeat command

Current unit: millimetres

Object style

OK

DN40

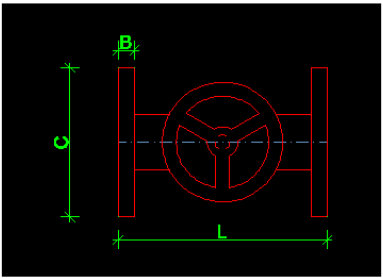

✓ CADprofi – editing elements using the *Quick Edit* command

The *Quick Edit*  command enables user to perform editing operations on symbols and objects instantly.

In the latest version of the program, the ability to edit elements using a dialog box has been added.

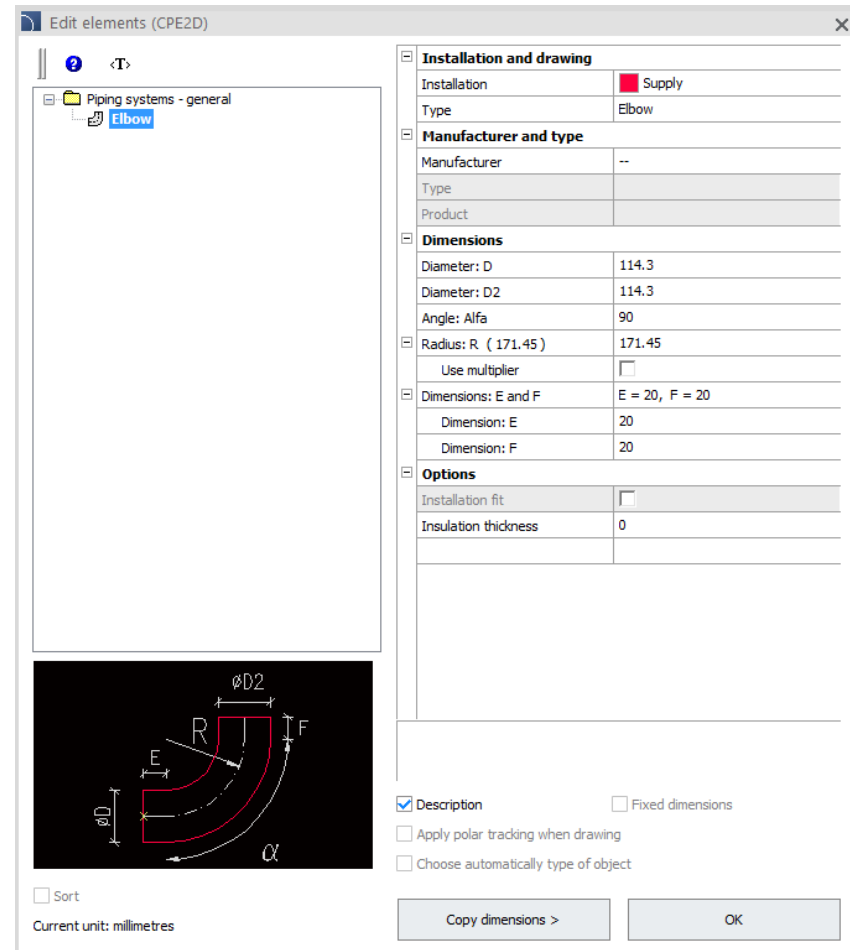
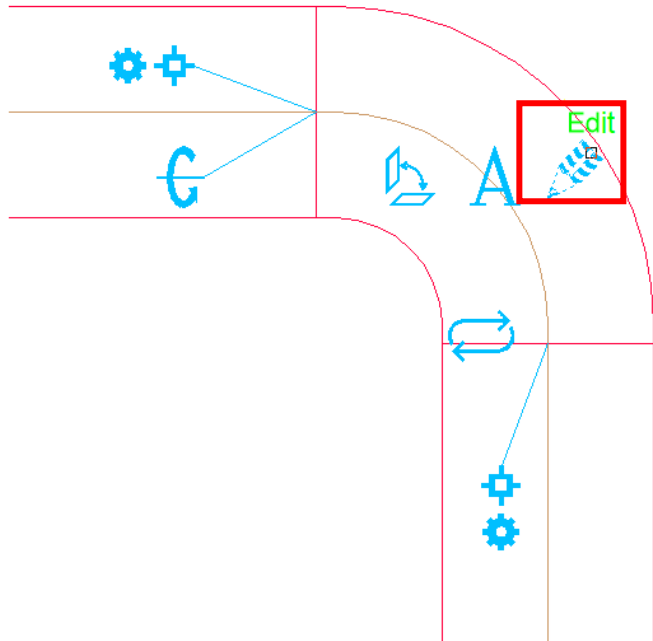

✓ CADprofi Architectural – fireplaces

CADprofi Architectural library have been extended with:

- Parametric wood fireplaces (single-glazed and corner).
- Wood burning fireplaces (single-glazed, corner, triple-glazed, double sided, with upper exchanger, without upper exchanger, rounded, square, with water jacket).
- Gas fireplaces (single-glazed and corner).
- Electric fireplaces (single-glazed and corner).
- Bio fireplaces (single-glazed, corner and triple-glazed).
- Stoves.

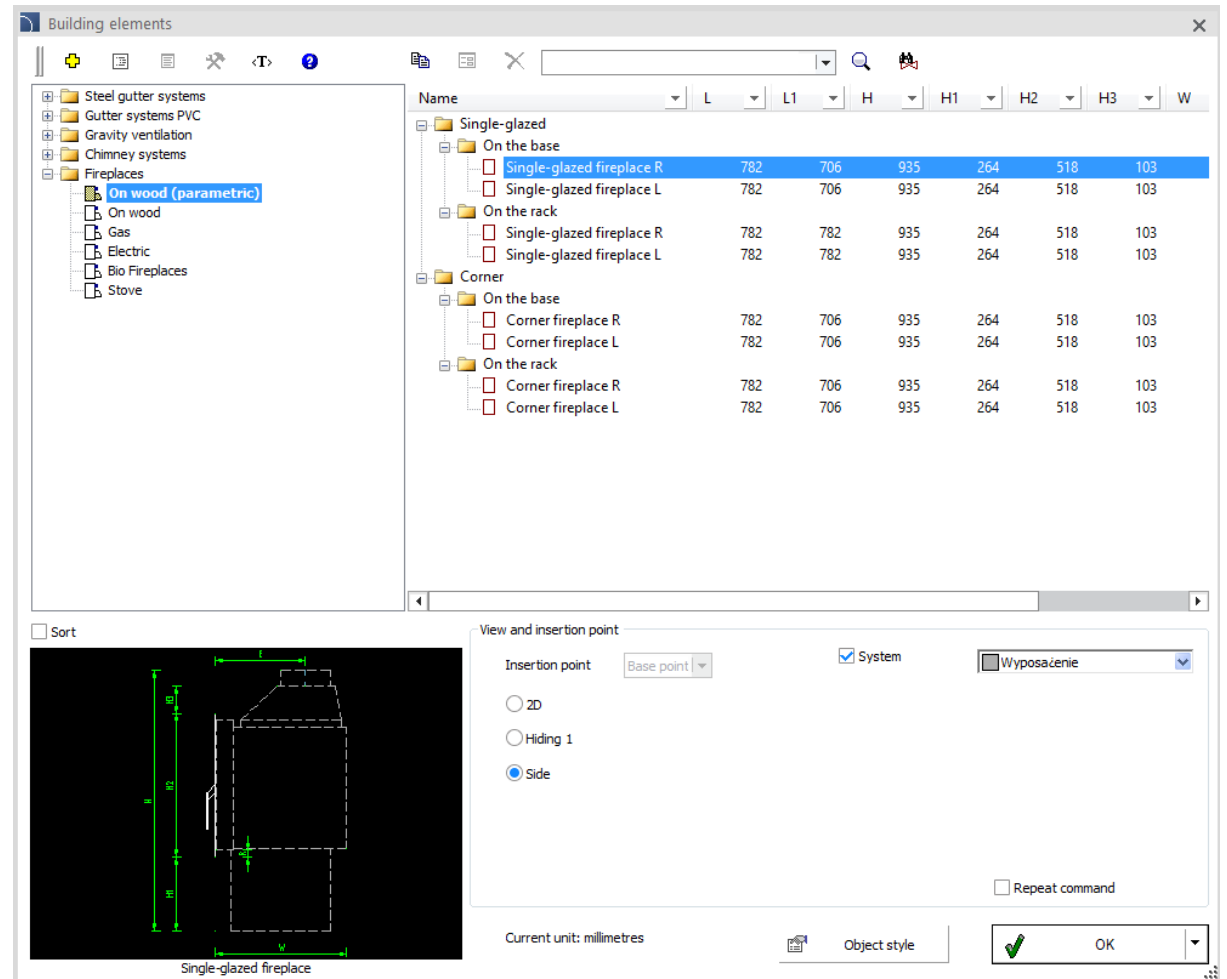

✓ CADprofi Architectural – room descriptions (maximum number of persons)

In the configurable room descriptions, the ability to specify the maximum number of people has been added.

1	Conference room
20 °C	21 people

Number 1 > >>>>	Name v
Temperature v	Number of people v

Name:	Conference room v	Lighting:	100 v lx
Height:	2.5 v m	Air in:	0 m ³ /h
Floor material:	PCV v	Air out:	0 m ³ /h
Temperature:	20 v °C	Heating:	0 W
		Number of people	21 v people
Area:	Real surface area	Floorage calculation	Floorage
		0% v	0.00
			Precision
			m ² v 0.00 v

✓ CADprofi HVAC & Piping – drainage channels

CADprofi HVAC & Piping library has been extended with drainage channels made of:

- plastic (100, 150, 200, 300),
- polimer concrete (100, 150, 200, 300, 400, 500).

Drainage channels are available in cross-section and top views.

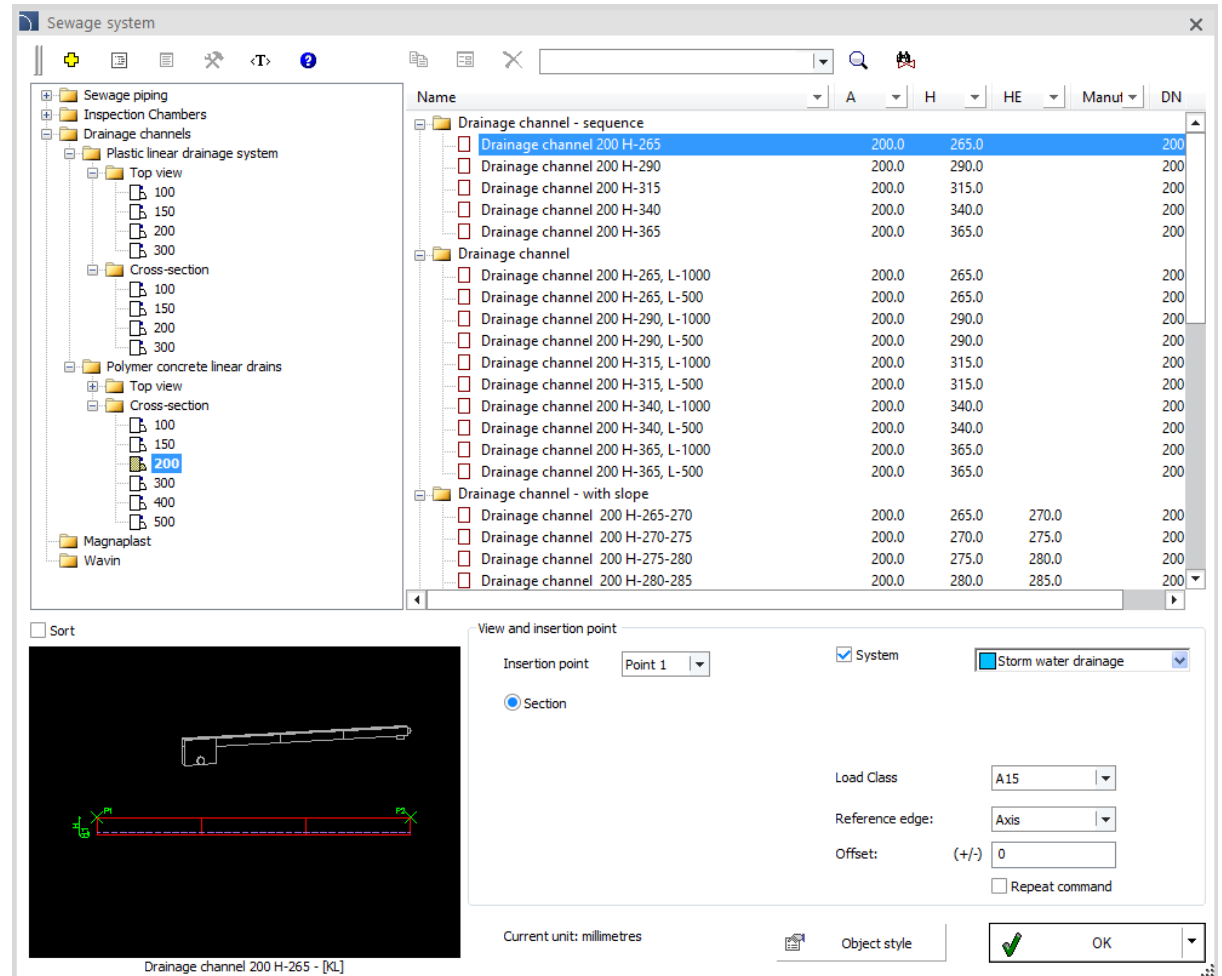



CADprofi

✓ Update of manufacturers' libraries:





CADprofi

✓ Adjustment to many base CAD programs

CADprofi 2021.11 has been adjusted to work with latest CAD programs, including: ARES Commander 2022 and ZWCAD 2022.
CADprofi 2021 currently works with many base CAD programs including: AutoCAD (since the 2000 version), BricsCAD, GstarCAD, IntelliCAD, progeCAD, ZWCAD, ARES Commander Edition and others.

The logo for AutoCAD, consisting of the word "AutoCAD" in a bold, red, sans-serif font with a registered trademark symbol.

The logo for ZWCAD, featuring the letters "ZWCAD" in a bold, blue, sans-serif font with a green leaf-like graphic above the "W".

The logo for GstarCAD, with "Gstar" in blue and "CAD" in yellow, followed by the tagline "An Alternative CAD System" in blue.

The logo for BricsCAD, featuring a stylized blue "B" shape above the word "BRICSCAD" in a bold, black, sans-serif font.

The logo for progeSOFT, featuring a blue globe with a yellow vertical bar and a yellow triangle above it, with the text "progeSOFT" below.

The logo for IntelliCAD, featuring a purple diamond shape with a yellow vertical bar and a yellow triangle above it, with the text "IntelliCAD" below.

The logo for Gräbert ARES Commander, featuring a red stylized flame or wing graphic to the left of the text "Gräbert ARES® Commander" in a black, sans-serif font.



CADprofi



CADprofi 2021.09

✓ CADprofi – quick editing of pipe lines/cable routes/busbars/cable trays

The new version of the program allows user to edit pipe lines/cable routes/busbars/cable trays thanks to the *Quick edit*  command.

The *Quick edit* command allows you to instantly edit the selected element, e.g. change of its length and position.

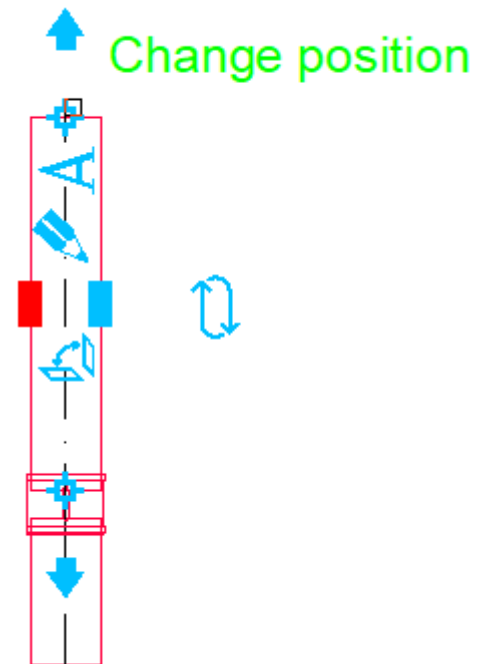



CADprofi

✓ CADprofi Architectural – chimney systems

Elements of gravity ventilation as well as single-draft and double-draft chimney systems have been added to the CADprofi Architectural library.

Schiedel and Hoch chimneys have also been added to the program library.



The screenshot shows the 'Building elements' library window. The left pane displays a tree view of chimney systems, including 'Chimneys Schiedel' and 'Chimneys HOCH'. The right pane shows a table of selected elements:

Name	Dimension X	Dimension Y	Dimension Z
Schiedel Rondo			
Rondo 16	34	34	33
Rondo 18	37	37	33
Rondo 20	39	39	33
Rondo 20 + V	56	39	33

Below the table is a preview window showing a 2D view of a chimney cross-section with a diagonal cut. The preview is labeled 'Chimney Schiedel Rondo 16'. To the right of the preview is a 'View and insertion point' dialog box with the following settings:

- Insertion point: Base point
- System: System
- Chimneys: Chimneys
- View: 2D, View 2, View 3
- Repeat command: Repeat command
- Current unit: centimetres
- Object style: [dropdown]
- OK: [button]

✓ CADprofi Architectural – update of fire safety symbols (DIN 14034 standard)

In the CADprofi Architectural program, new symbols for evacuation, fire protection and health & safety have been updated and introduced based on the DIN 14034 standard.

Additionally, in the *safety and evacuation symbols*  command, the possibility of inserting symbols with a leader line has been introduced.

Leader

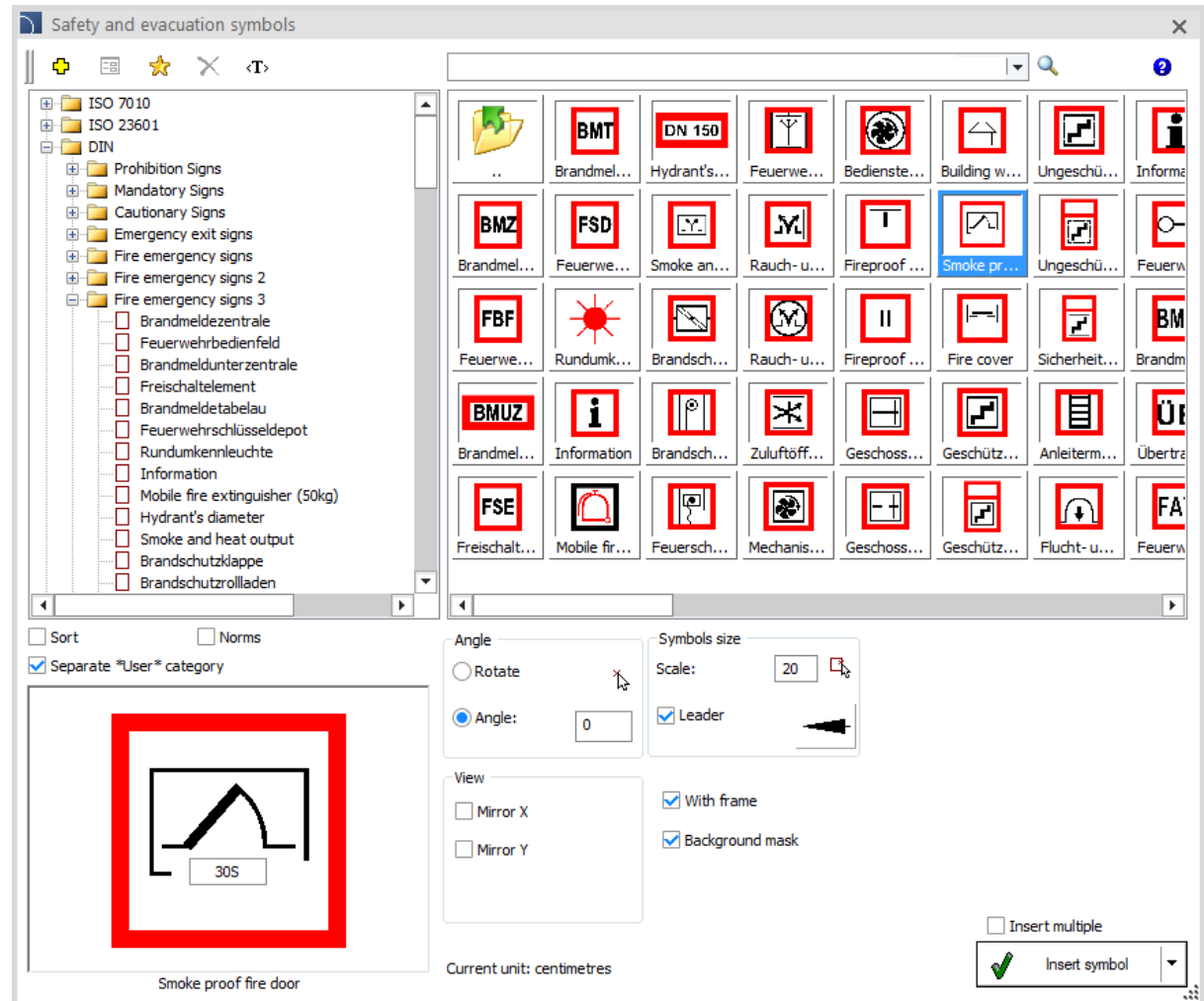

✓ CADprofi Architectural – customizable room definitions

New, fully customizable room definitions have been added to CADprofi Architectural.

1	Technical room
7.24 m ²	PCV 100lx

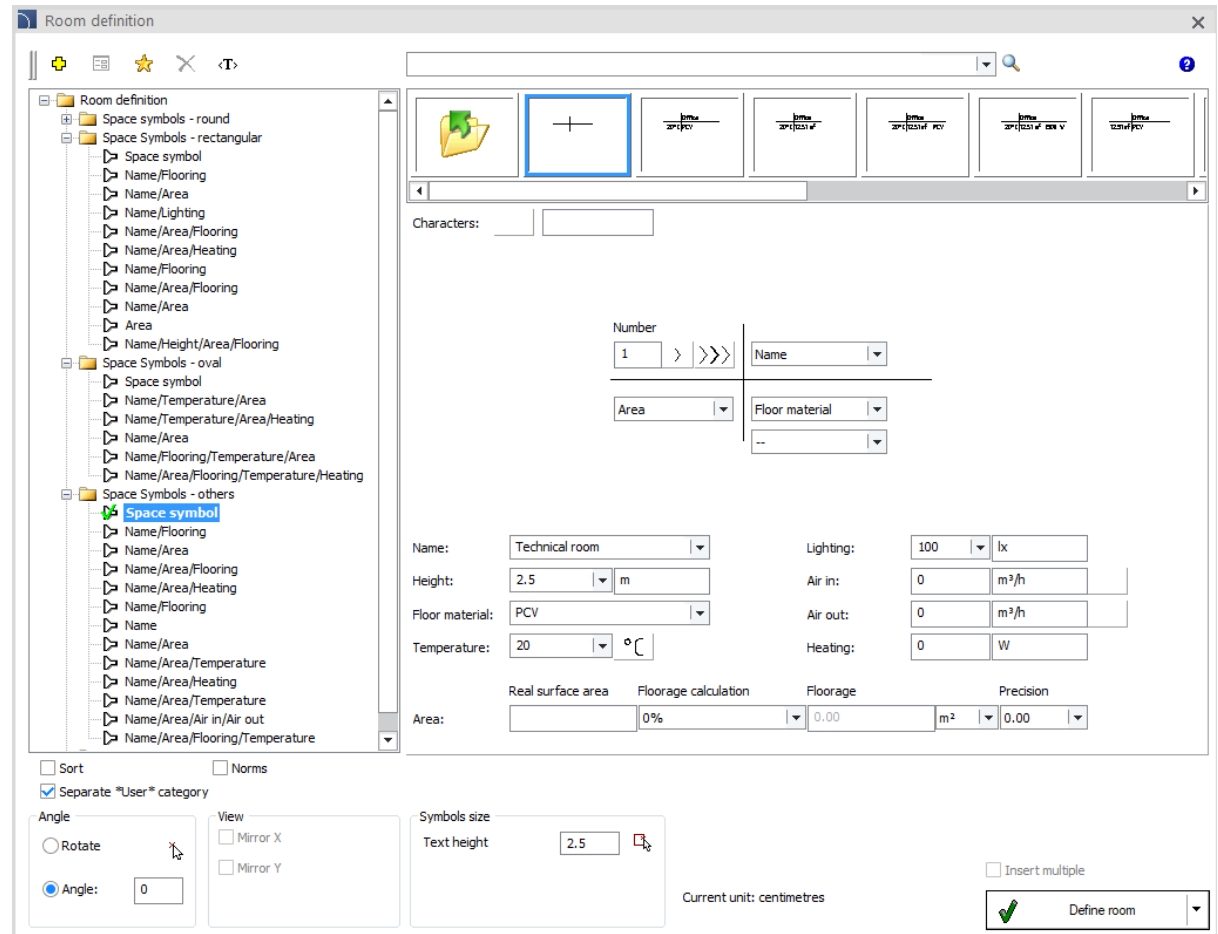

Room definition

Room definition

- Space symbols - round
 - Space Symbols - rectangular
 - Space symbol
 - Name/Flooring
 - Name/Area
 - Name/Lighting
 - Name/Area/Flooring
 - Name/Area/Heating
 - Name/Flooring
 - Name/Area/Flooring
 - Name/Area
 - Area
 - Name/Height/Area/Flooring
 - Space Symbols - oval
 - Space symbol
 - Name/Temperature/Area
 - Name/Temperature/Area/Heating
 - Name/Area
 - Name/Flooring/Temperature/Area
 - Name/Area/Flooring/Temperature/Heating
 - Space Symbols - others
 - Space symbol**
 - Name/Flooring
 - Name/Area
 - Name/Area/Flooring
 - Name/Area/Heating
 - Name/Flooring
 - Name
 - Name/Area
 - Name/Area/Temperature
 - Name/Area/Heating
 - Name/Area/Temperature
 - Name/Area/Temperature
 - Name/Area/Air in/Air out
 - Name/Area/Flooring/Temperature

Characters: _____

Number: 1 > >>> Name: _____

Area: _____ Floor material: _____

Name: Technical room Lighting: 100 lx

Height: 2.5 m Air in: 0 m³/h

Floor material: PCV Air out: 0 m³/h

Temperature: 20 °C Heating: 0 W

Area: _____ Real surface area: _____ Floorage calculation: _____ Floorage: 0.00 m² Precision: 0.00

Sort Norms

Separate *User* category

Angle: Rotate Angle: 0

View: Mirror X Mirror Y

Symbols size: Text height: 2.5

Current unit: centimetres

Insert multiple

Define room

✓ CADprofi Architectural – stairs (front views)

Front views of one-flight, stringer and cantilevered stairs have been added to CADprofi Architectural.

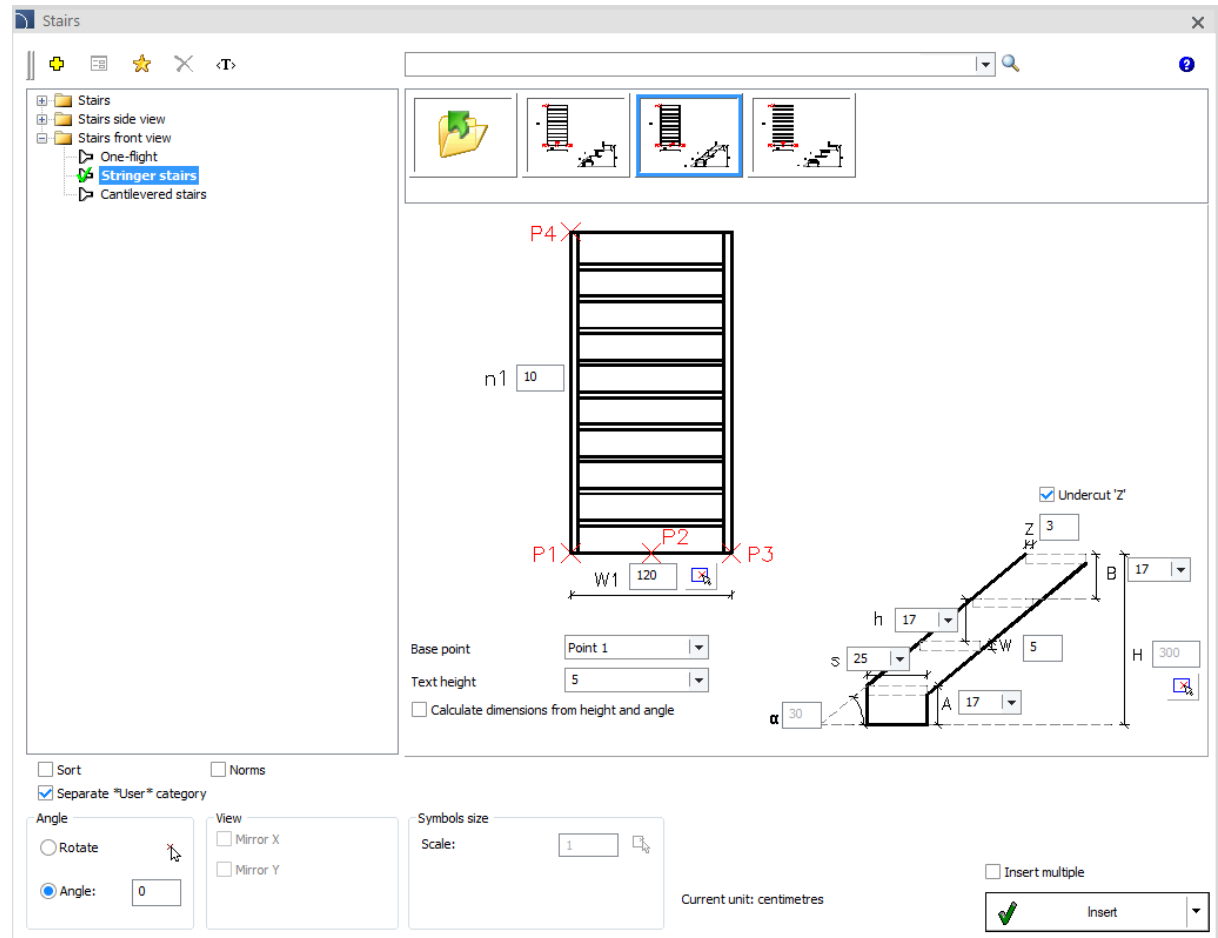

✓ CADprofi Architectural – changes in the Doors, windows command

The following features have been added to the Doors, windows command:

- New threshold drawing styles.
- Possibility to show wall outline.
- Back views (windows).
- Ability to define your own window dimensions.

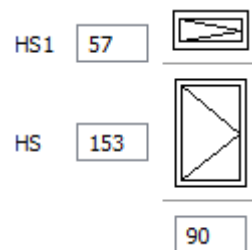

Name	W	H	HS	R	BR
Window - single for public building construction	90	210	153	9	5
By dimensions of hole window					
60 x 175	60	175	118	9	5
90 x 175	90	175	118	9	5
60 x 205	60	205	148	9	5
90 x 205	90	205	148	9	5
60 x 210	60	210	153	9	5
90 x 210	90	210	153	9	5
60 x 235	60	235	178	9	5
90 x 235	90	235	178	9	5
By dimensions of window					
56 x 175	56	175	118	9	5
86 x 175	86	175	118	9	5
56 x 205	56	205	148	9	5
86 x 205	86	205	148	9	5
56 x 210	56	210	153	9	5
86 x 210	86	210	153	9	5
56 x 235	56	235	178	9	5
86 x 235	86	235	178	9	5

Sort
 Insertion point: Plan Front view Back view Section
 Window diagram:
 HS1: HS:
 W: BR: BZ: BW: BW2:
 Thickness: GZ: Thickness: G:
 Windowsill height: H1:
 Wall outline:
 Jamb:
 Apply left Apply right
 Repeat command
 Current unit: centimetres

✓ CADprofi Electrical – miniature contactors

Miniature contactors (3P, 4P) with additional accessories have been added to the *Modular units*  command.

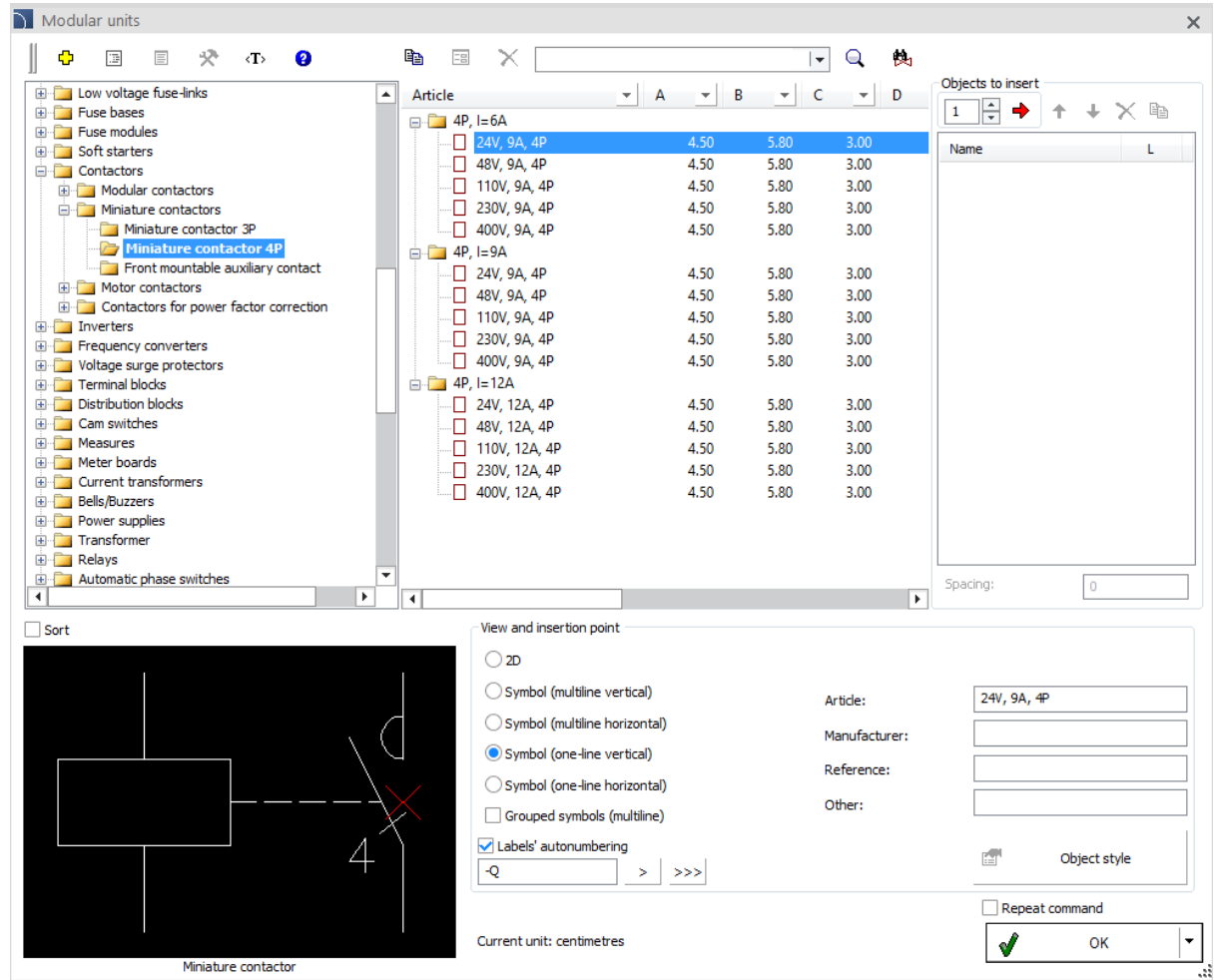

The screenshot shows the 'Modular units' command interface. The left pane displays a tree view of electrical components, with 'Miniature contactor 4P' selected. The main pane displays a table of articles with columns for voltage, current, and dimensions. The bottom pane shows a 2D schematic of a miniature contactor and configuration options for the insertion point and labels.

Article	A	B	C	D
4P, I=6A				
24V, 9A, 4P	4.50	5.80	3.00	
48V, 9A, 4P	4.50	5.80	3.00	
110V, 9A, 4P	4.50	5.80	3.00	
230V, 9A, 4P	4.50	5.80	3.00	
400V, 9A, 4P	4.50	5.80	3.00	
4P, I=9A				
24V, 9A, 4P	4.50	5.80	3.00	
48V, 9A, 4P	4.50	5.80	3.00	
110V, 9A, 4P	4.50	5.80	3.00	
230V, 9A, 4P	4.50	5.80	3.00	
400V, 9A, 4P	4.50	5.80	3.00	
4P, I=12A				
24V, 12A, 4P	4.50	5.80	3.00	
48V, 12A, 4P	4.50	5.80	3.00	
110V, 12A, 4P	4.50	5.80	3.00	
230V, 12A, 4P	4.50	5.80	3.00	
400V, 12A, 4P	4.50	5.80	3.00	

View and insertion point options:

- 2D
- Symbol (multiline vertical)
- Symbol (multiline horizontal)
- Symbol (one-line vertical)
- Symbol (one-line horizontal)
- Grouped symbols (multiline)
- Labels' autonumbering

Article: 24V, 9A, 4P
 Manufacturer:
 Reference:
 Other:

Current unit: centimetres

Repeat command:

OK

✓ CADprofi Electrical – update of descriptions library

Additional IEC/NFPA address symbols have been added to the *Descriptions* ³ command.

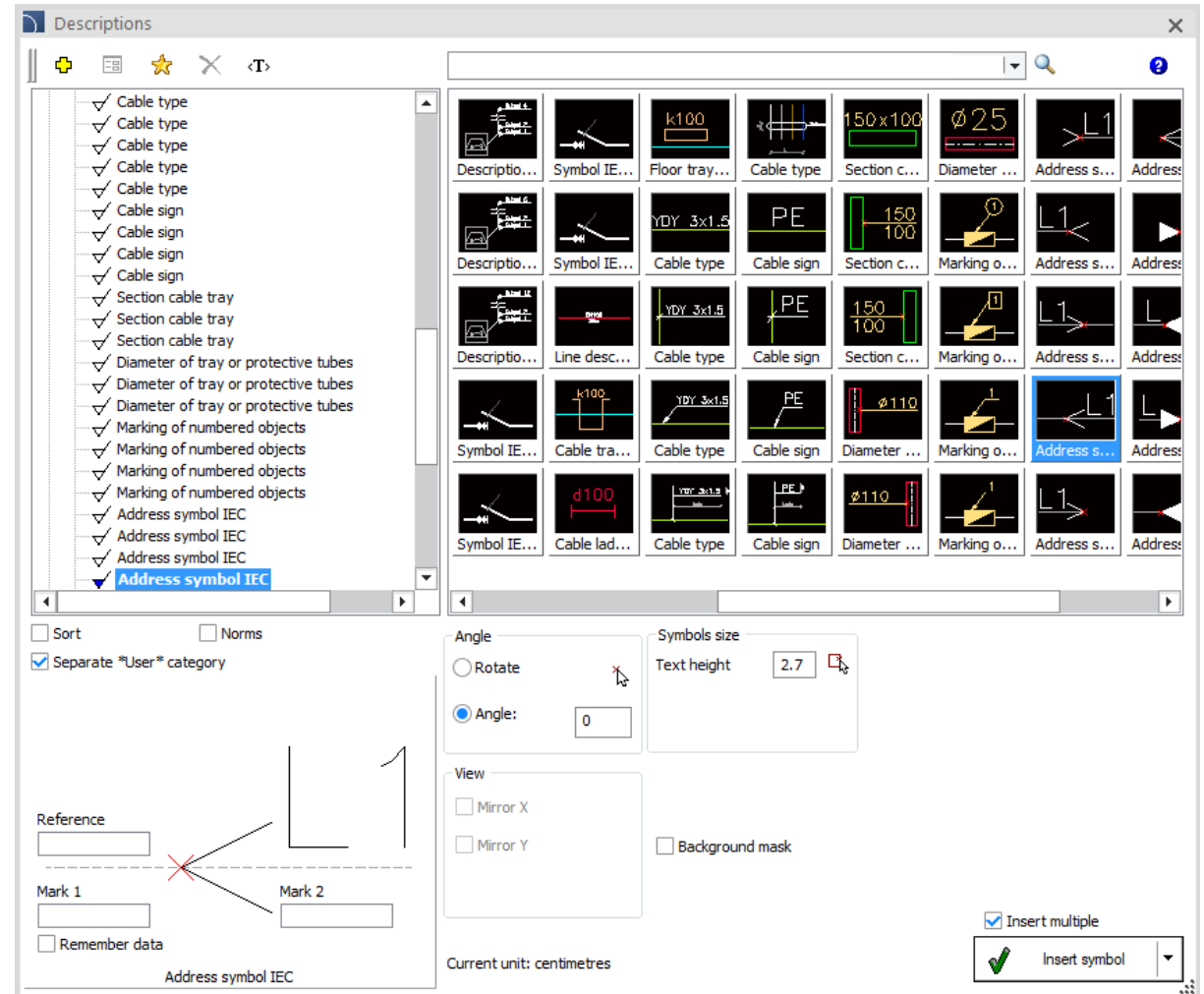

✓ CADprofi Electrical – system cabinets

System cabinets (flush-mounted, wall-mounted, floor standing) with system elements have been added to the

Switchgear  command:

- Modules for modular, vertical devices.
- Modules for circuit breakers / switch disconnectors.
- Modules for box fuse switch disconnectors.
- Modules for vertical fuse switch disconnectors.
- Modules for industrial switch disconnectors with fuses.
- Modules with rail for cable holders.

Program allows user to select an appropriate switchgear on the basis of devices selected from the drawing.



Choose a cabinet for the selected apparatus from the drawing

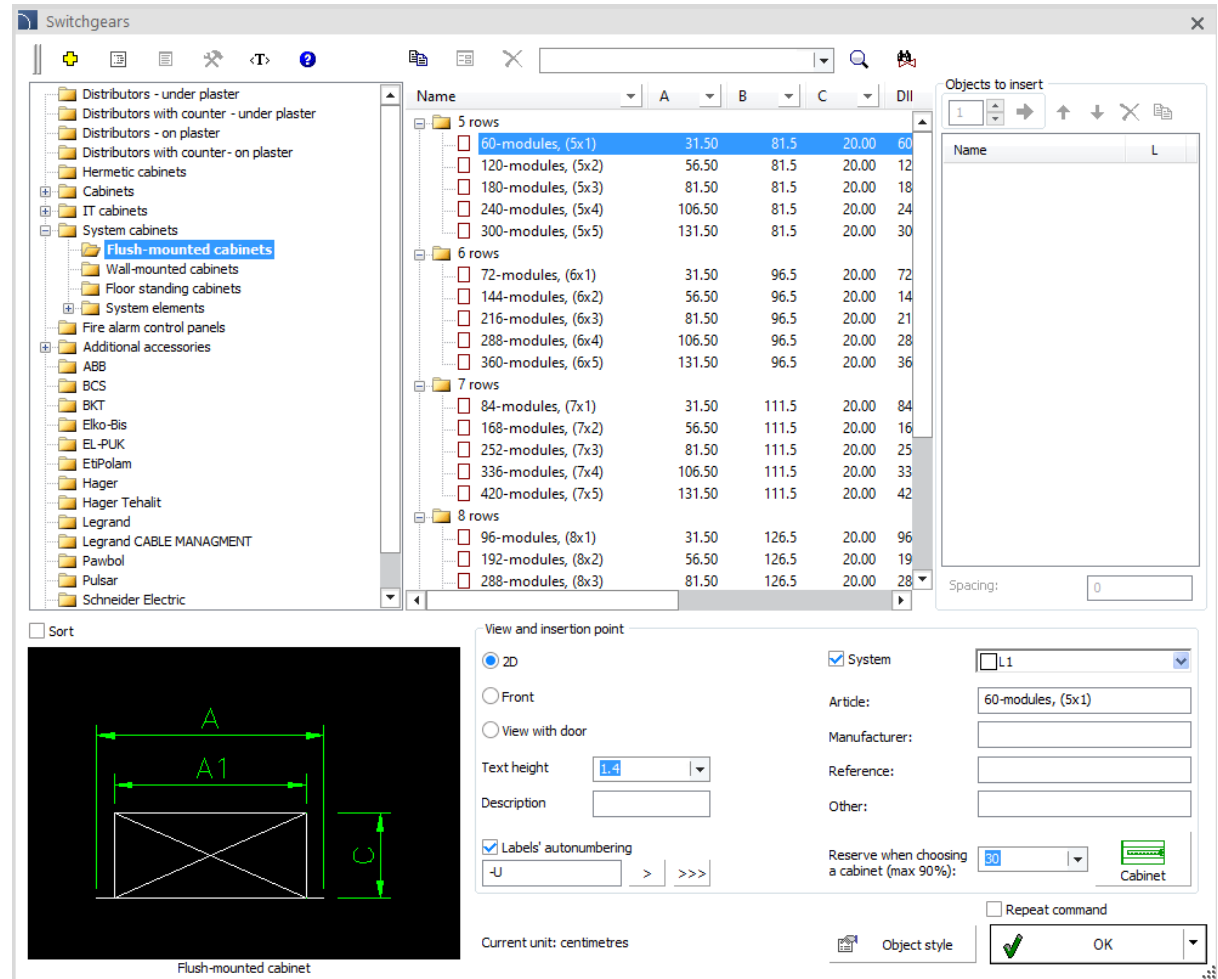

Name	A	B	C	D
5 rows				
60-modules, (5x1)	31.50	81.5	20.00	60
120-modules, (5x2)	56.50	81.5	20.00	12
180-modules, (5x3)	81.50	81.5	20.00	18
240-modules, (5x4)	106.50	81.5	20.00	24
300-modules, (5x5)	131.50	81.5	20.00	30
6 rows				
72-modules, (6x1)	31.50	96.5	20.00	72
144-modules, (6x2)	56.50	96.5	20.00	14
216-modules, (6x3)	81.50	96.5	20.00	21
288-modules, (6x4)	106.50	96.5	20.00	28
360-modules, (6x5)	131.50	96.5	20.00	36
7 rows				
84-modules, (7x1)	31.50	111.5	20.00	84
168-modules, (7x2)	56.50	111.5	20.00	16
252-modules, (7x3)	81.50	111.5	20.00	25
336-modules, (7x4)	106.50	111.5	20.00	33
420-modules, (7x5)	131.50	111.5	20.00	42
8 rows				
96-modules, (8x1)	31.50	126.5	20.00	96
192-modules, (8x2)	56.50	126.5	20.00	19
288-modules, (8x3)	81.50	126.5	20.00	28

Flush-mounted cabinet

✓ CADprofi Electrical – update of fire safety symbols library

Fire protection symbols library available in the *Symbols - other* command has been extended with additional types of detectors, control panels and monitoring and control modules.

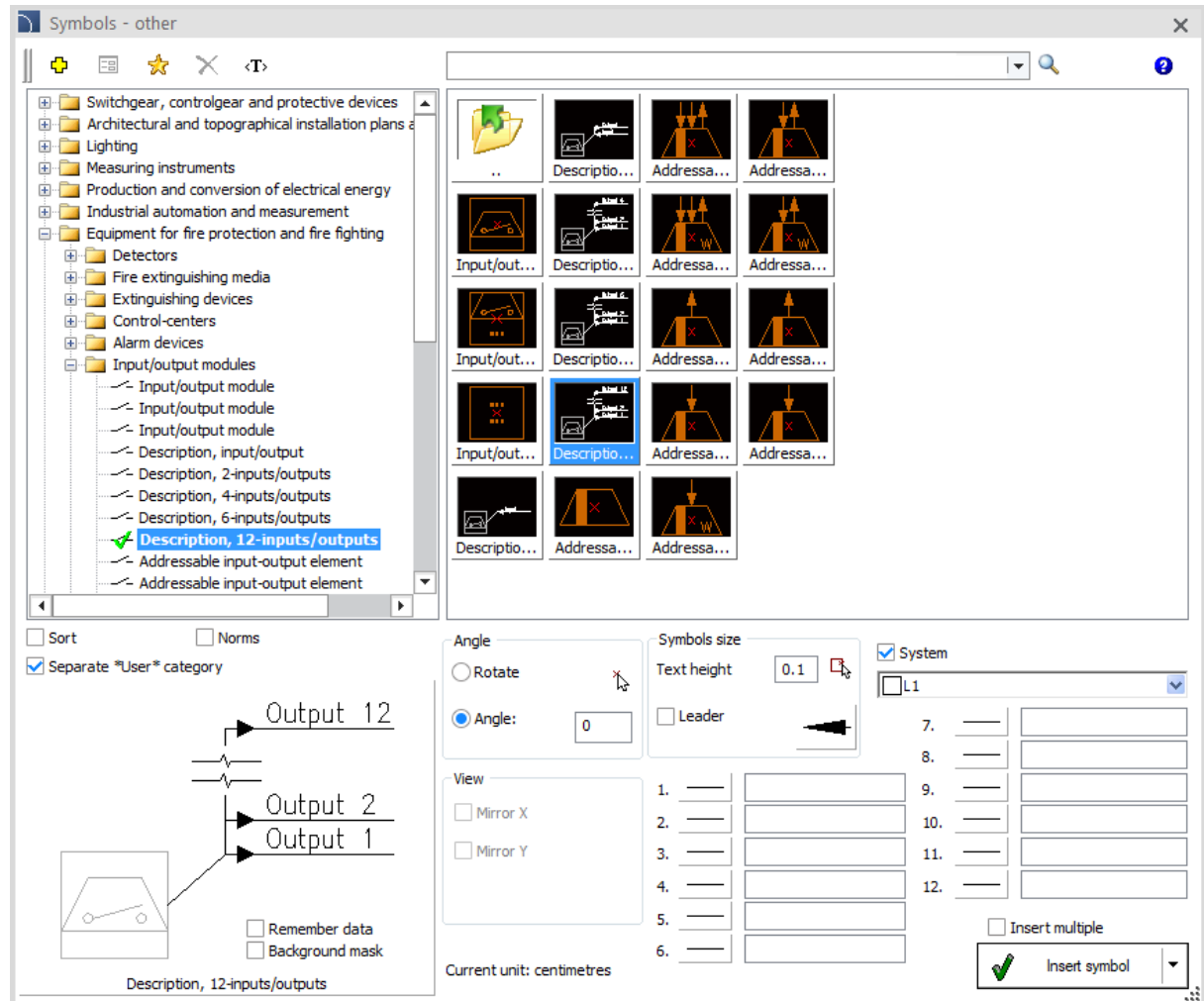

✓ CADprofi HVAC & Piping – extending the functionality of manifolds

In the *Parametrical objects*  command, the possibility to select the start and end elements of the manifold has been added.

Start element

End element

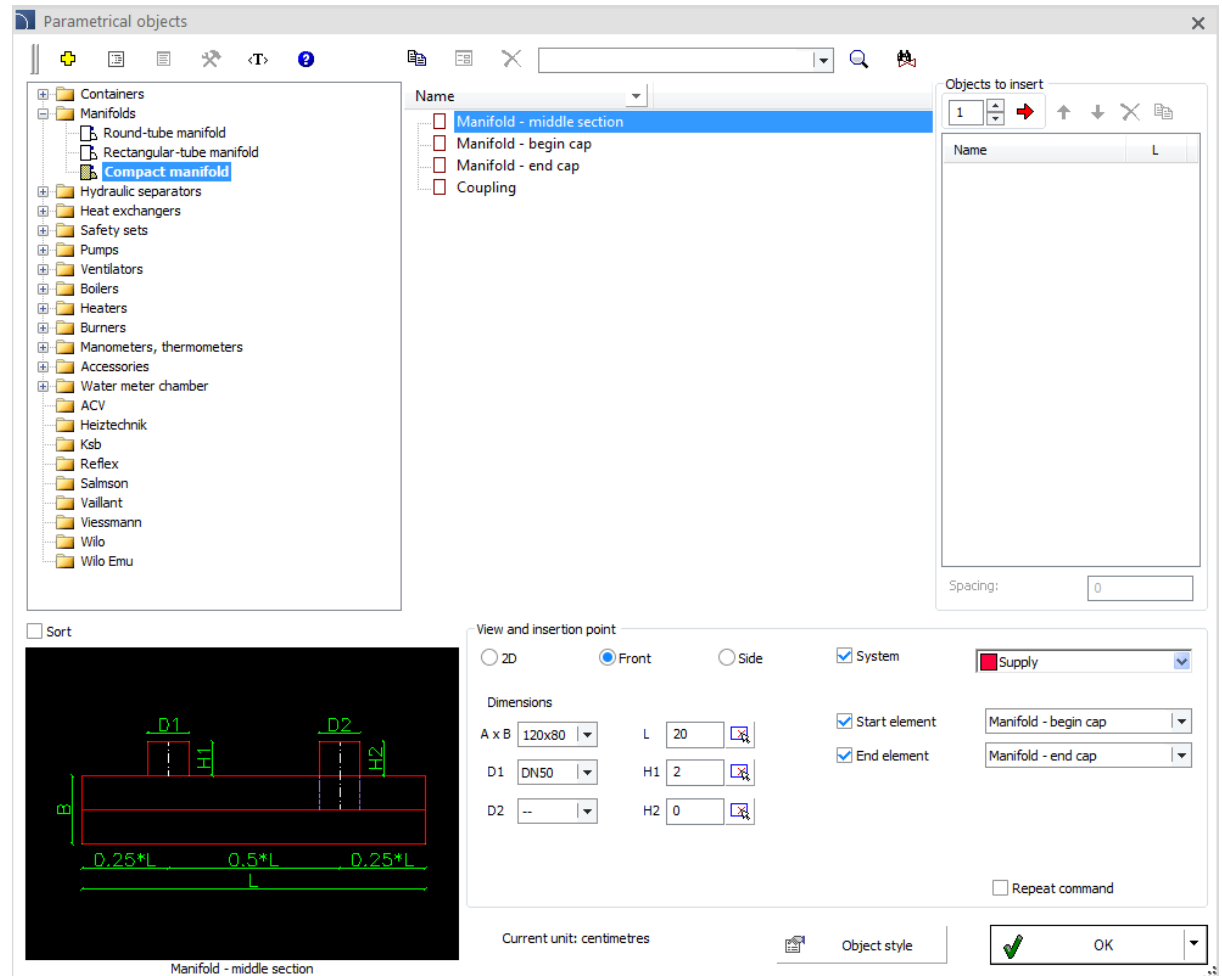

Parametrical objects

Objects to insert

- Manifold - middle section
- Manifold - begin cap
- Manifold - end cap
- Coupling

View and insertion point

2D Front Side System

Dimensions

A x B: 120x80 L: 20

D1: DN50 H1: 2

D2: -- H2: 0

Start element

End element

Repeat command

Current unit: centimetres Spacing: 0

Manifold - middle section

Diagram showing dimensions: D1, D2, H1, H2, L, B, and section lengths: 0.25*L, 0.5*L, 0.25*L.



CADprofi

✓ CADprofi HVAC & Piping – air flow velocity marks

Air flow velocity marks have been added to the Ventilation - Marks ⇨ command.

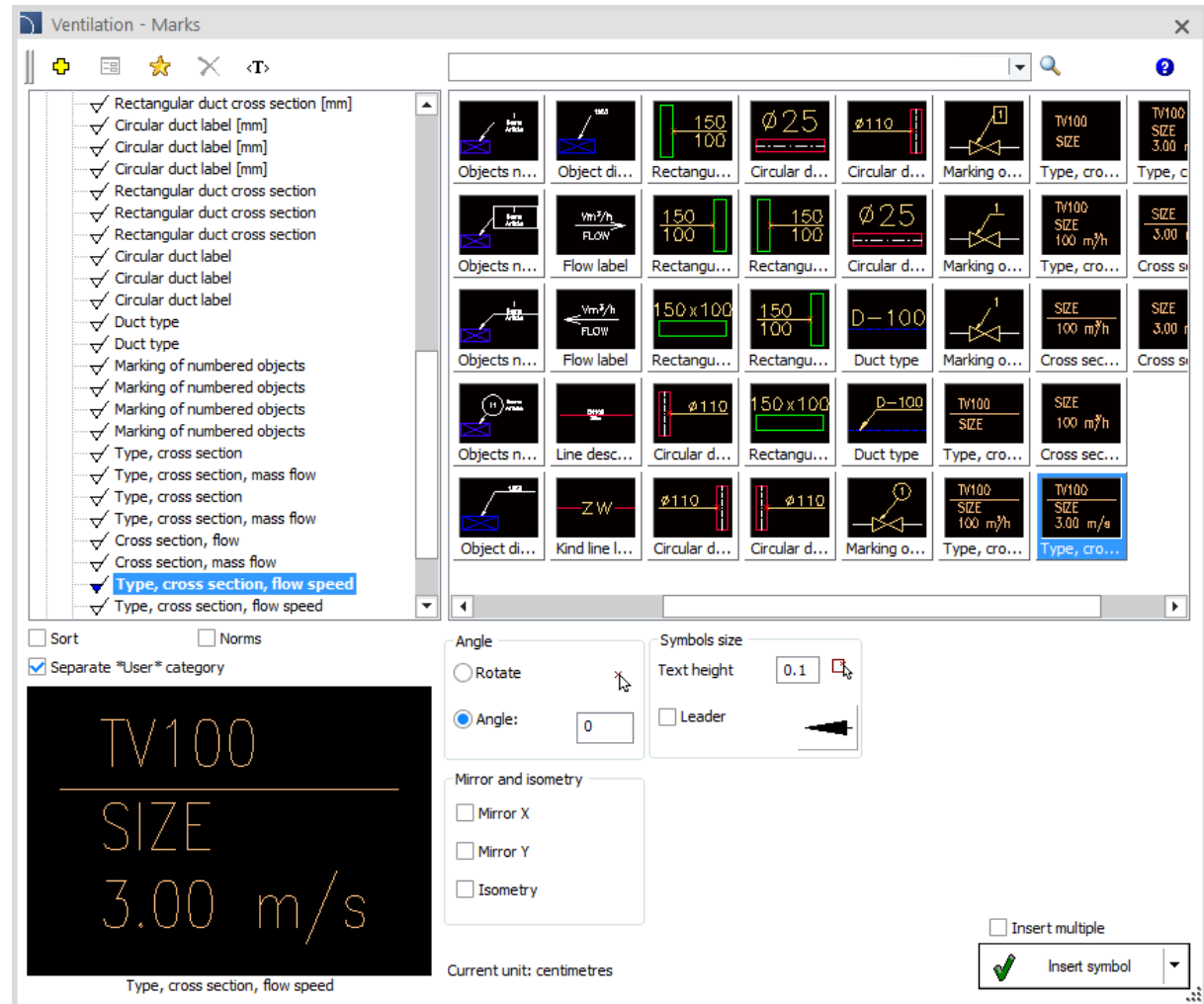

✓ CADprofi HVAC & Piping – additional types of connectors and valves

Mounting plates as well as semi-screw and wall connectors have been added to the

Pipes - detailed views  command.

Polypropylene pipes have been extended with additional sizes (125, 160, 200, 250, 315, 355, 400, 450).

The following valves has been added to the *Armature*  command:

- Ball valve with filter.
- Semi-screw ball valve.
- Tapping valve.
- Drain valve.
- Valve with male thread on both sides.
- Ball valve with nut.

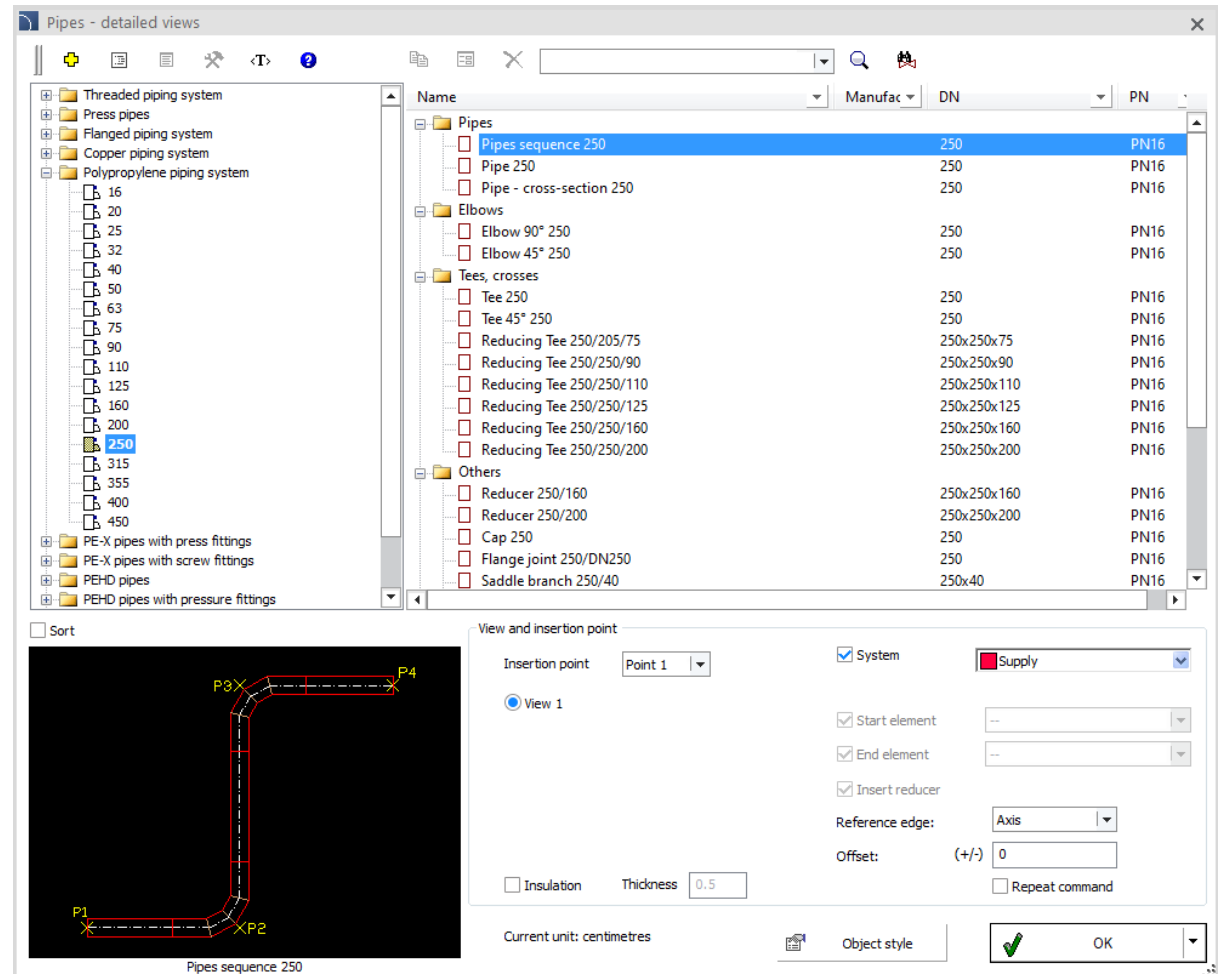

Name	DN	PN
Pipes		
Pipes sequence 250	250	PN16
Pipe 250	250	PN16
Pipe - cross-section 250	250	PN16
Elbows		
Elbow 90° 250	250	PN16
Elbow 45° 250	250	PN16
Tees, crosses		
Tee 250	250	PN16
Tee 45° 250	250	PN16
Reducing Tee 250/205/75	250x250x75	PN16
Reducing Tee 250/250/90	250x250x90	PN16
Reducing Tee 250/250/110	250x250x110	PN16
Reducing Tee 250/250/125	250x250x125	PN16
Reducing Tee 250/250/160	250x250x160	PN16
Reducing Tee 250/250/200	250x250x200	PN16
Others		
Reducer 250/160	250x250x160	PN16
Reducer 250/200	250x250x200	PN16
Cap 250	250	PN16
Flange joint 250/DN250	250	PN16
Saddle branch 250/40	250x40	PN16

View and insertion point

Insertion point: Point 1

System: Supply

View 1

Start element: --

End element: --

Insert reducer

Reference edge: Axis

Offset: (+/-) 0

Insulation Thickness: 0.5

Current unit: centimetres

Object style:  OK

✓ CADprofi Mechanical – quick editing for additional elements

The *Quick edit*  option has been introduced in CADprofi Mechanical for:

- Threaded holes.
- Pre-drilling for the heads of screws and bolts.
- Clearance holes for screws and bolts.

The Quick edit command allows user to instantly edit a selected item, including change its length and position.

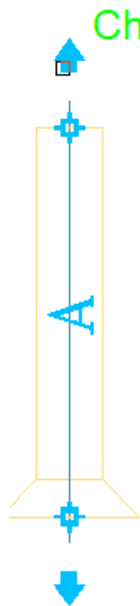
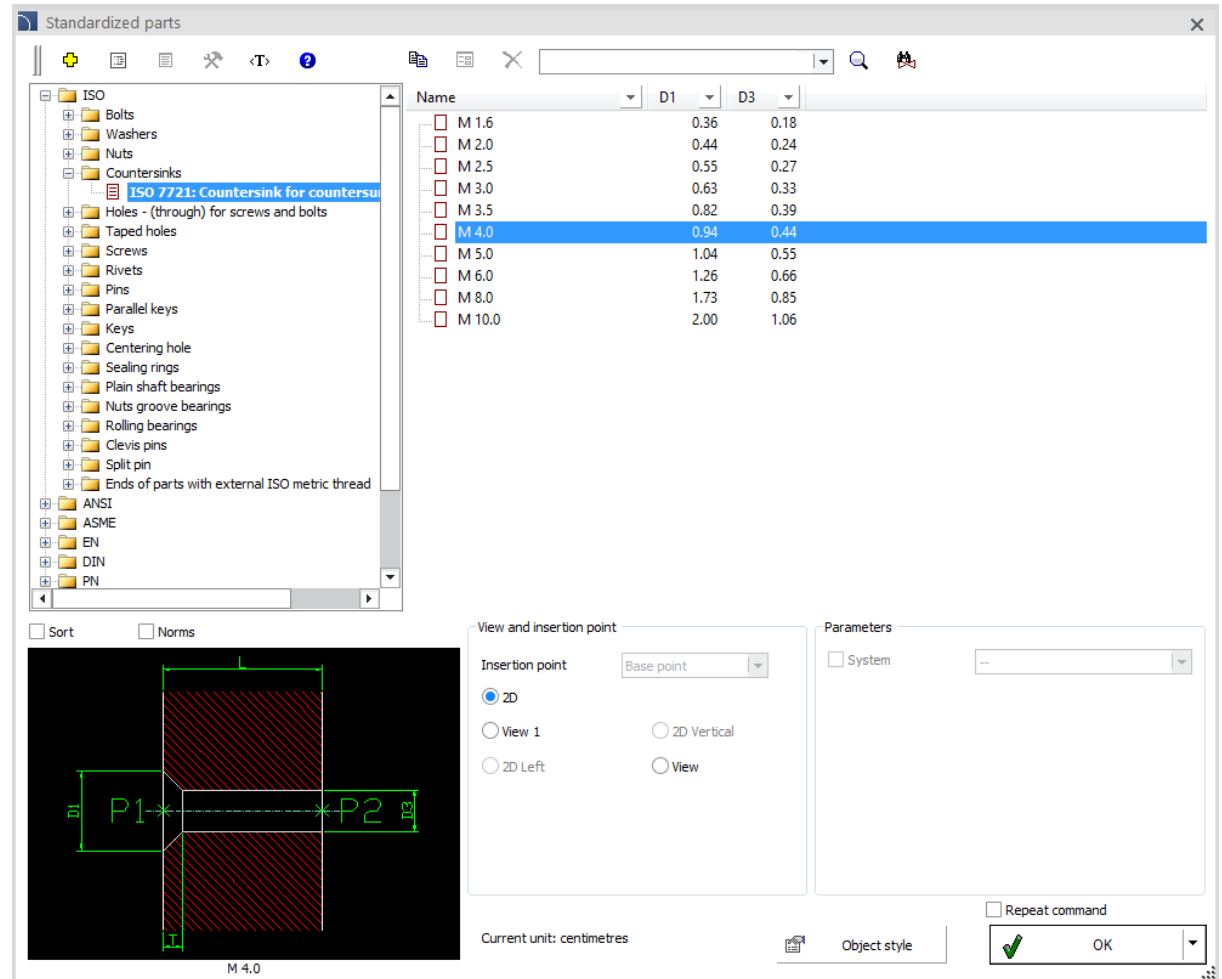
Name	D1	D3
M 1.6	0.36	0.18
M 2.0	0.44	0.24
M 2.5	0.55	0.27
M 3.0	0.63	0.33
M 3.5	0.82	0.39
M 4.0	0.94	0.44
M 5.0	1.04	0.55
M 6.0	1.26	0.66
M 8.0	1.73	0.85
M 10.0	2.00	1.06

View and insertion point
 Insertion point: Base point
 2D
 View 1
 2D Vertical
 2D Left
 View

Parameters
 System

Current unit: centimetres
 Repeat command
 OK



CADprofi

✓ Update of manufacturers' libraries:





CADprofi

✓ Adjustment to many base CAD programs

CADprofi 2021.09 has been adjusted to work with latest CAD programs, including: AutoCAD 2022 and ActCAD 2021 Standard.
CADprofi 2021 currently works with many base CAD programs including: AutoCAD (since the 2000 version), BricsCAD, GstarCAD, IntelliCAD, progeCAD, ZWCAD, ARES Commander Edition and others.

The logo for AutoCAD, with the word "AutoCAD" in a bold, red, sans-serif font.

The logo for ZWCAD, with "ZW" in blue and "CAD" in a larger blue font, featuring a green leaf-like graphic above the "W".

The logo for GstarCAD, with "Gstar" in blue and "CAD" in yellow, followed by the tagline "An Alternative CAD System" in blue.

The logo for BricsCAD, featuring a stylized blue "B" shape above the word "BRICSCAD" in a bold, black, sans-serif font.

The logo for progeSOFT, featuring a blue globe with a yellow vertical bar and a yellow triangle on top, above the text "progeSOFT" in a blue, sans-serif font.

The logo for IntelliCAD, featuring a purple diamond shape with a yellow vertical bar and a yellow triangle on top, above the text "IntelliCAD" in a bold, black, sans-serif font.

The logo for Gräbert ARES Commander, featuring a red stylized flame or wing graphic to the left of the text "Gräbert ARES® Commander" in a black, sans-serif font.



CADprofi



CADprofi 2021.07

✓ CADprofi – drawing walls and lines along the infoline

New version of the program allows user to instantly draw walls and schematic lines along the indicated infoline.

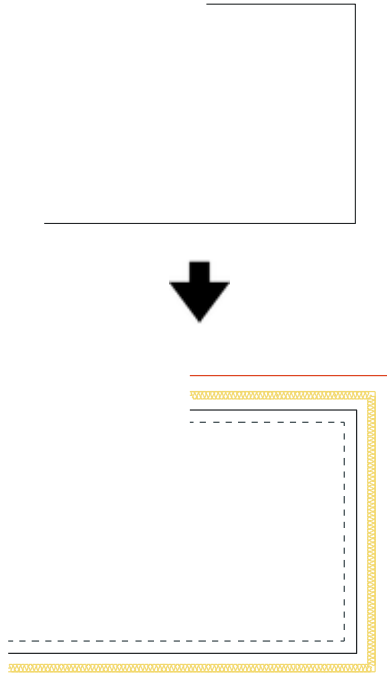
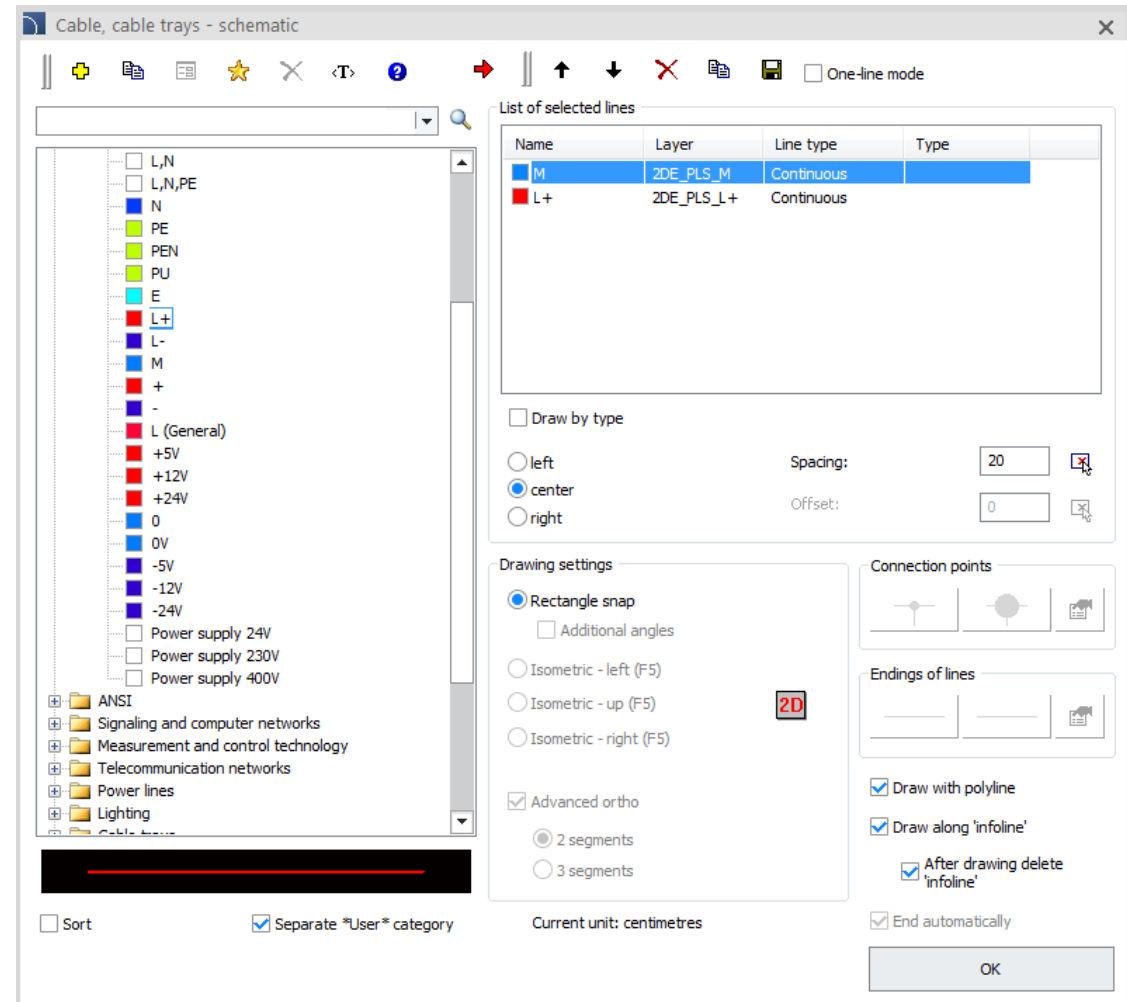
The screenshot shows the CADprofi software interface for drawing cable trays. The window title is "Cable, cable trays - schematic". The interface includes a toolbar, a list of selected lines, and various drawing settings.

Name	Layer	Line type	Type
M	2DE_PLS_M	Continuous	
L+	2DE_PLS_L+	Continuous	

Drawing settings:

- Draw by type
- left
- center
- right
- Spacing: 20
- Offset: 0
- Rectangle snap
- Additional angles
- Isometric - left (F5)
- Isometric - up (F5)
- Isometric - right (F5)
- Advanced ortho
- 2 segments
- 3 segments

Connection points:

Endings of lines:

- Draw with polyline
- Draw along 'infoline'
- After drawing delete 'infoline'
- End automatically



Current unit: centimetres

Buttons: OK

✓ CADprofi – additional options for inserting circle axes and center marks

There are additional commands in CADprofi that facilitate the creation of technical drawings. These commands are available in the top menu and on the "CADprofi - quick tools" toolbar.



One of those commands are *Circle axes*  and *Center marks* . The latest version of the program can detect all circles in the selected block and automatically insert circle axes or center marks in them.

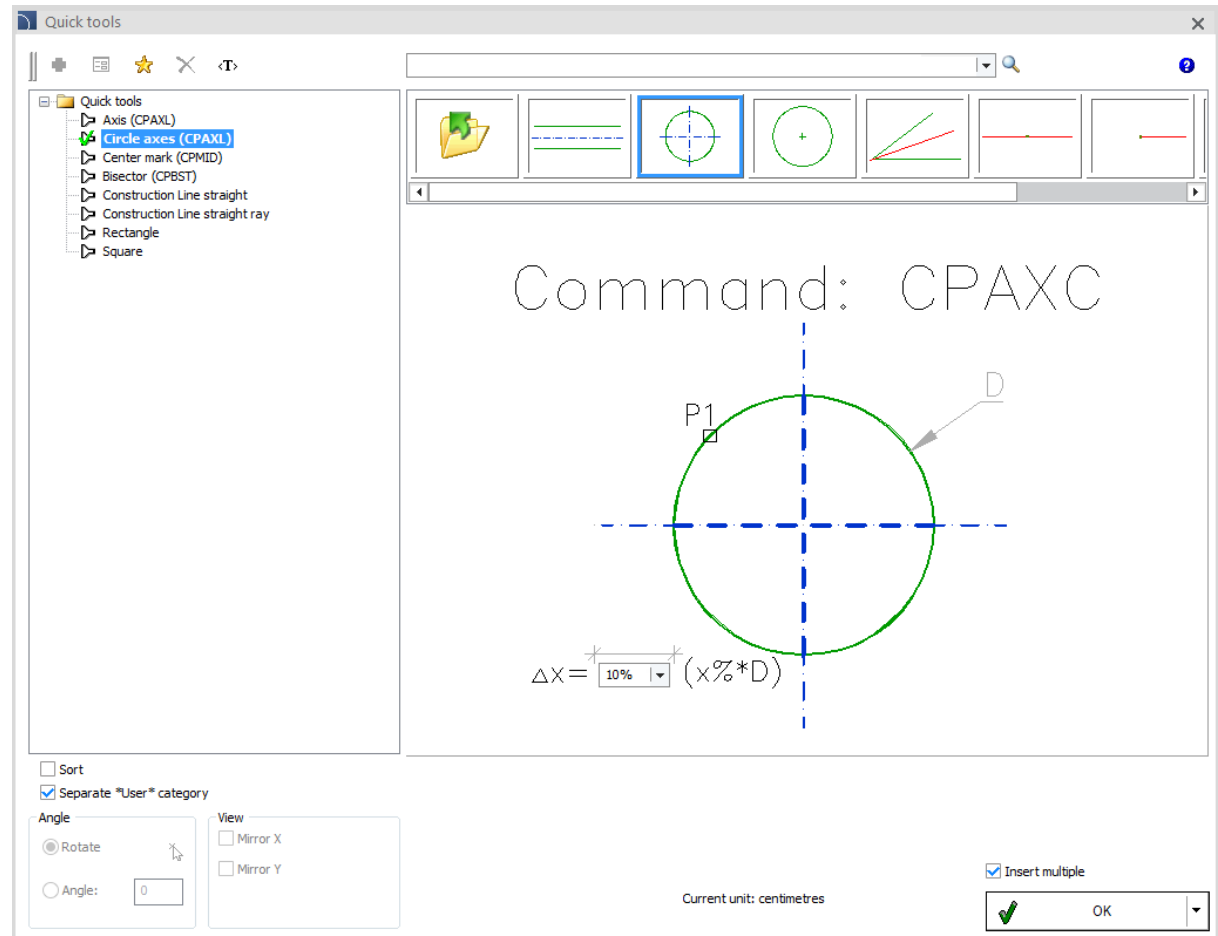
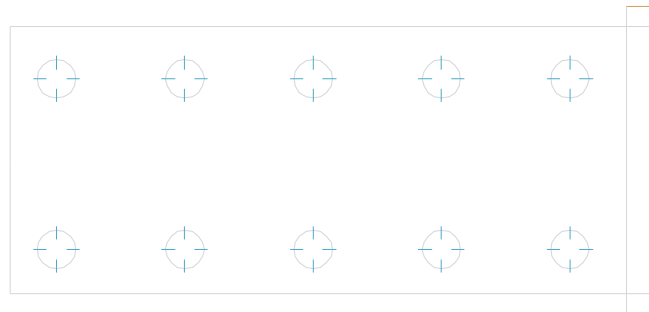



CADprofi

✓ CADprofi – new keyboard shortcuts for commands

In CAD programs, each user can change and define keyboard shortcuts to commands. These shortcuts can be associated not only with CAD program commands, but also with CADprofi program commands. CADprofi also has internal command shortcuts that work independently of user-defined shortcuts:

General commands

CPX	Previous CADprofi command
CVP	Clear drawing from unused definitions
CPLMNU*/CPUMNU*	Menu load / unload (some CAD programs only)

Edit commands

CPDEL	Delete symbols
QED	Quick edit
CPEXP	CADprofi – explode
CPED	Edit symbols
CPINS	Insert similar object
CPVIEW	Create alternative view
CPTRAY	Match properties
CPPLS	Schematic lines - edit
CPJ2D	Join general elements
CPJVD	Join detailed elements
CPDIV	Divide general elements
CPE2D	Edit elements
CPISO	Insulation of general elements
CPFL	Flanges of general elements

Quick drawing tools

CPAXL	Axis
CPAXC	Circle axes
CPMID	Center mark
CPBST	Bisector

✓ CADprofi Electrical – extension of modular apparatus library

Modular apparatus library available in CADprofi program has been extended with:

- Measuring relay for differential current.
- 4P contactors.
- 1NO, 1NC front auxiliary contacts for motor contactors.
- Multifunctional modular and panel meters.
- Narrow profile interface relays.
- MCBs and residual current devices with overcurrent module RCBO - single-module.
- AFDD arc fault detectors - single-module.
- AFDD arc fault detectors for MCBs and RCBOs.

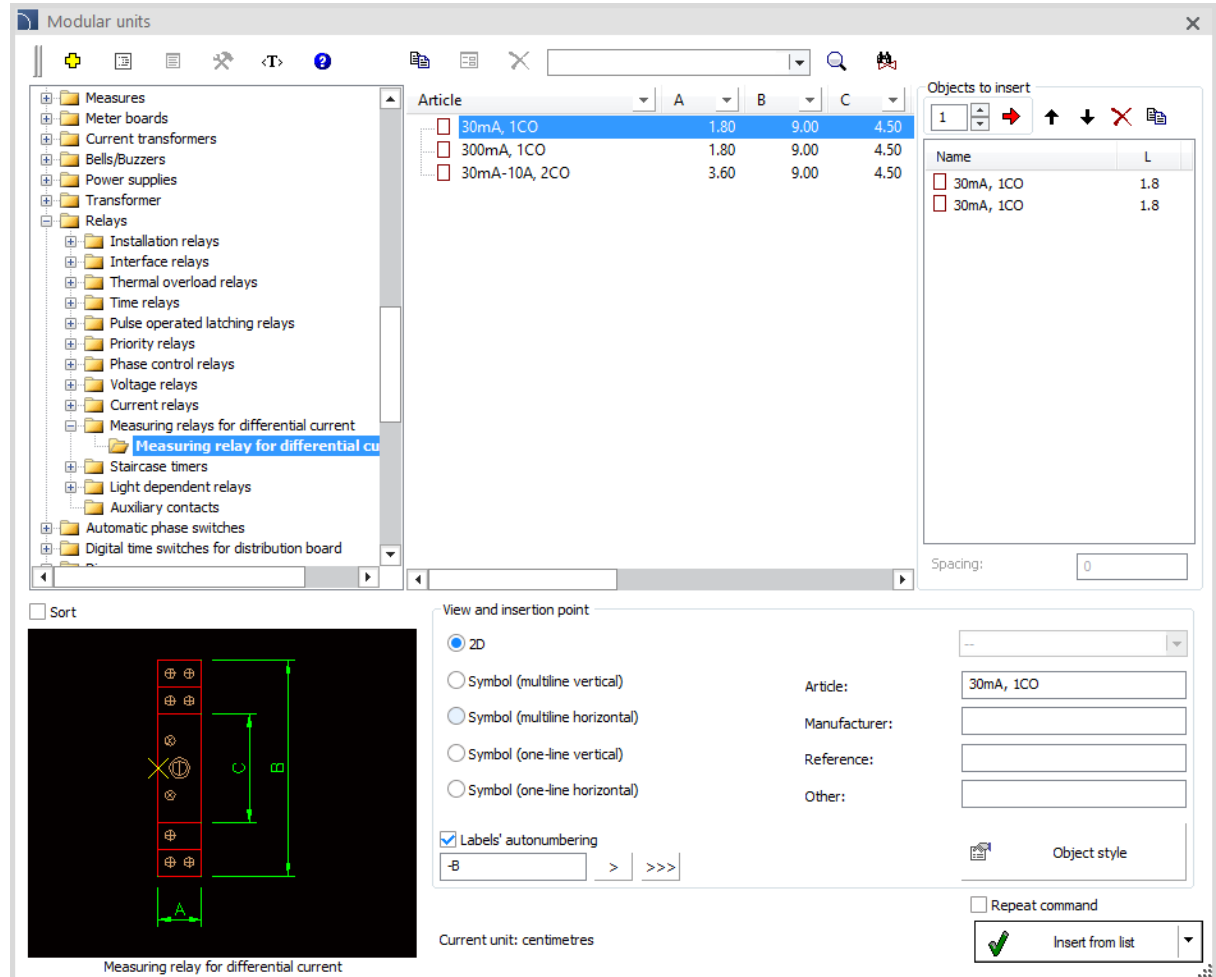

The screenshot displays the 'Modular units' window in CADprofi. The left-hand tree view shows a hierarchy of electrical components, with 'Measuring relay for differential current' highlighted under the 'Relays' category. The central 'Article' table lists three items:

Article	A	B	C
30mA, 1CO	1.80	9.00	4.50
300mA, 1CO	1.80	9.00	4.50
30mA-10A, 2CO	3.60	9.00	4.50

The right-hand 'Objects to insert' panel shows a table with two entries:

Name	L
30mA, 1CO	1.8
30mA, 1CO	1.8

At the bottom, a 2D technical drawing of the 'Measuring relay for differential current' is shown with dimensions A and C. The 'View and insertion point' panel is set to '2D' and includes fields for 'Article' (30mA, 1CO), 'Manufacturer', 'Reference', and 'Other'. A 'Repeat command' checkbox is also present.

✓ CADprofi Electrical – plastic trays

Cable plastic trays with accessories have been added to the *Busbars and cable trays* command.

It is possible to create top and front views (view of installation, e.g. on the walls).

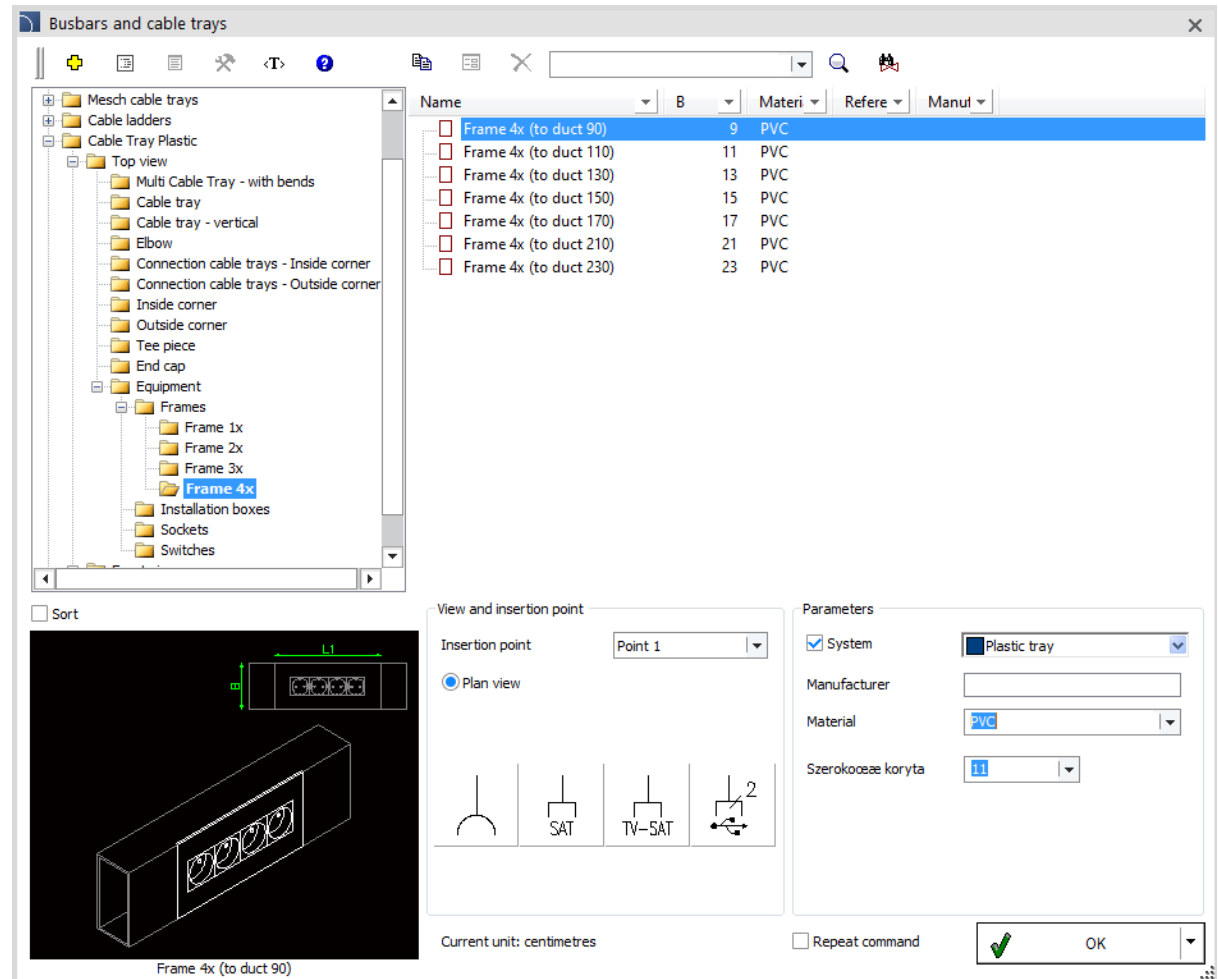



CADprofi

✓ CADprofi HVAC & Piping – extension of inspection chambers

New types (200, 630, 800, 1000) of inspection chambers have been added in both detailed and schematic views.

The screenshot displays the CADprofi software interface for a 'Sewage system'. The left pane shows a tree view of 'Inspection Chambers' categorized by 'DN 110' and 'DN 400', with sub-categories for 'detailed view' and 'schematic view'. The right pane lists various chamber types, such as 'Chamber with straight – through chamber base' and 'Chamber with connection chamber base', with columns for 'Name', 'DN', and 'Product-type'. The bottom section features a technical drawing of a chamber with dimensions labeled (DK, D, H1, H2, A, L, LK, DP, P1, P2, P3, P4) and a 'View and insertion point' panel with settings for 'System', 'Sewage', 'Point 1', and dimensions H1 = 27.5 and H2 = 200. The current unit is set to centimetres.

Name	DN	Product-type
Chamber		
TYPE 200		
outflow with a chalice		
Chamber with straight – through chamber base	DN110	TYPE 200
outflow without a chalice		
Chamber with straight – through chamber base	DN110	TYPE 200
TYPE 400		
outflow with a chalice		
Chamber with straight – through chamber base	DN110	TYPE 400
Chamber with connection chamber base, 3 inlets 2x45°	DN110	TYPE 400
Chamber with connection chamber base, 3 inlets 2x90°	DN110	TYPE 400
Chamber with connection chamber base, 2 inlets 1x45°	DN110	TYPE 400
Chamber with connection chamber base, 2 inlets 1x90°	DN110	TYPE 400
Chamber with bend flow channel base 90°	DN110	TYPE 400
Chamber with bend flow channel base 45°	DN110	TYPE 400
Chamber with bend flow channel base 30°	DN110	TYPE 400
outflow without a chalice		
Chamber with straight – through chamber base	DN110	TYPE 400
Chamber with connection chamber base, 3 inlets 2x45°	DN110	TYPE 400
Chamber with connection chamber base, 3 inlets 2x90°	DN110	TYPE 400

✓ CADprofi HVAC & Piping – anemostats without expansion box

Anemostats without expansion boxes have been added to the *Outlets*  command.

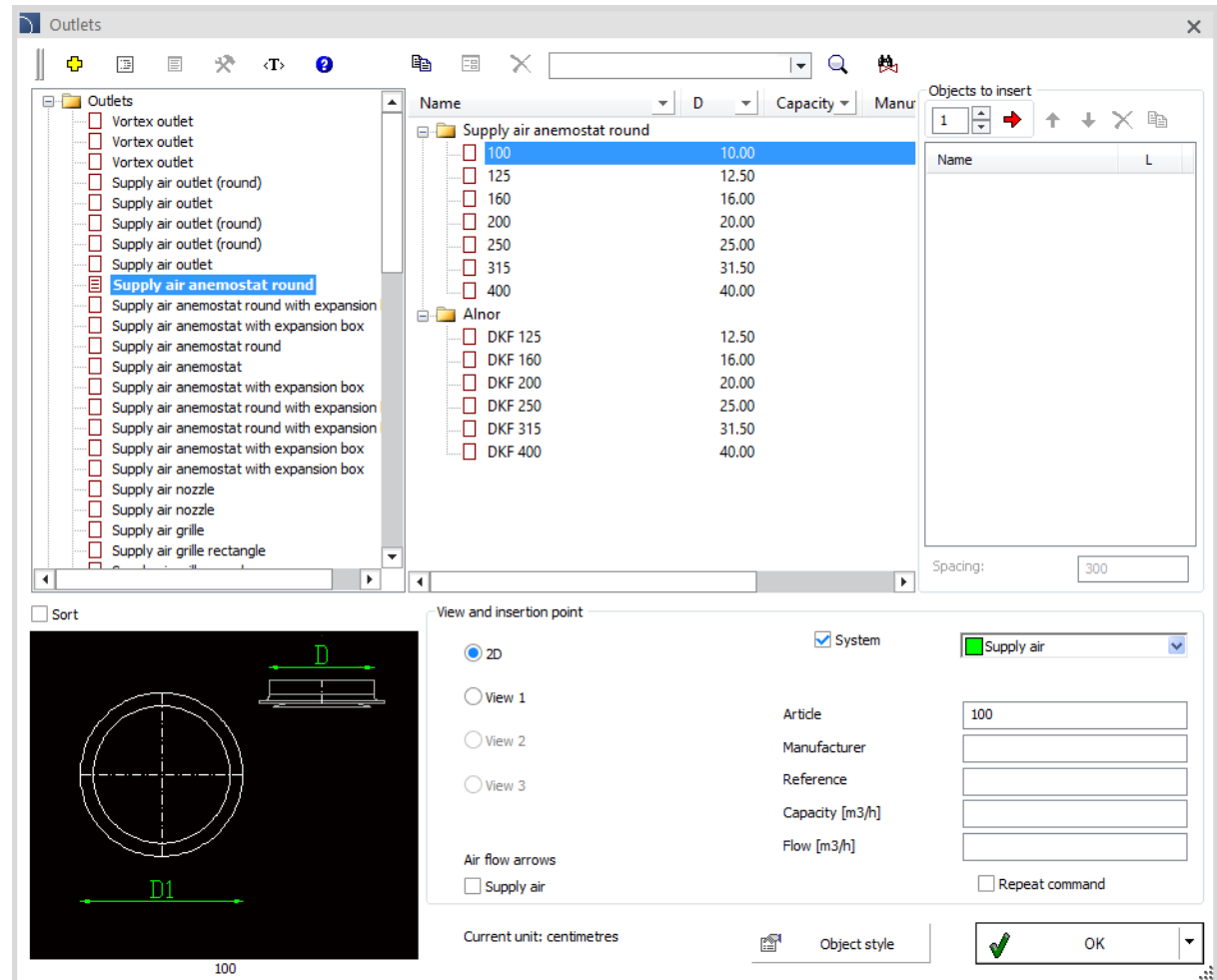

✓ CADprofi HVAC & Piping – combined semi-screw fittings

Unions and half pipe-unions have been added to the polypropylene piping system in the *Pipes – detailed views* .

Half pipe-unions (3/8", 1/2", 3/4", 1", 1 1/4", 1 1/2", 2") have been added to the *Parametrical armature*  command.

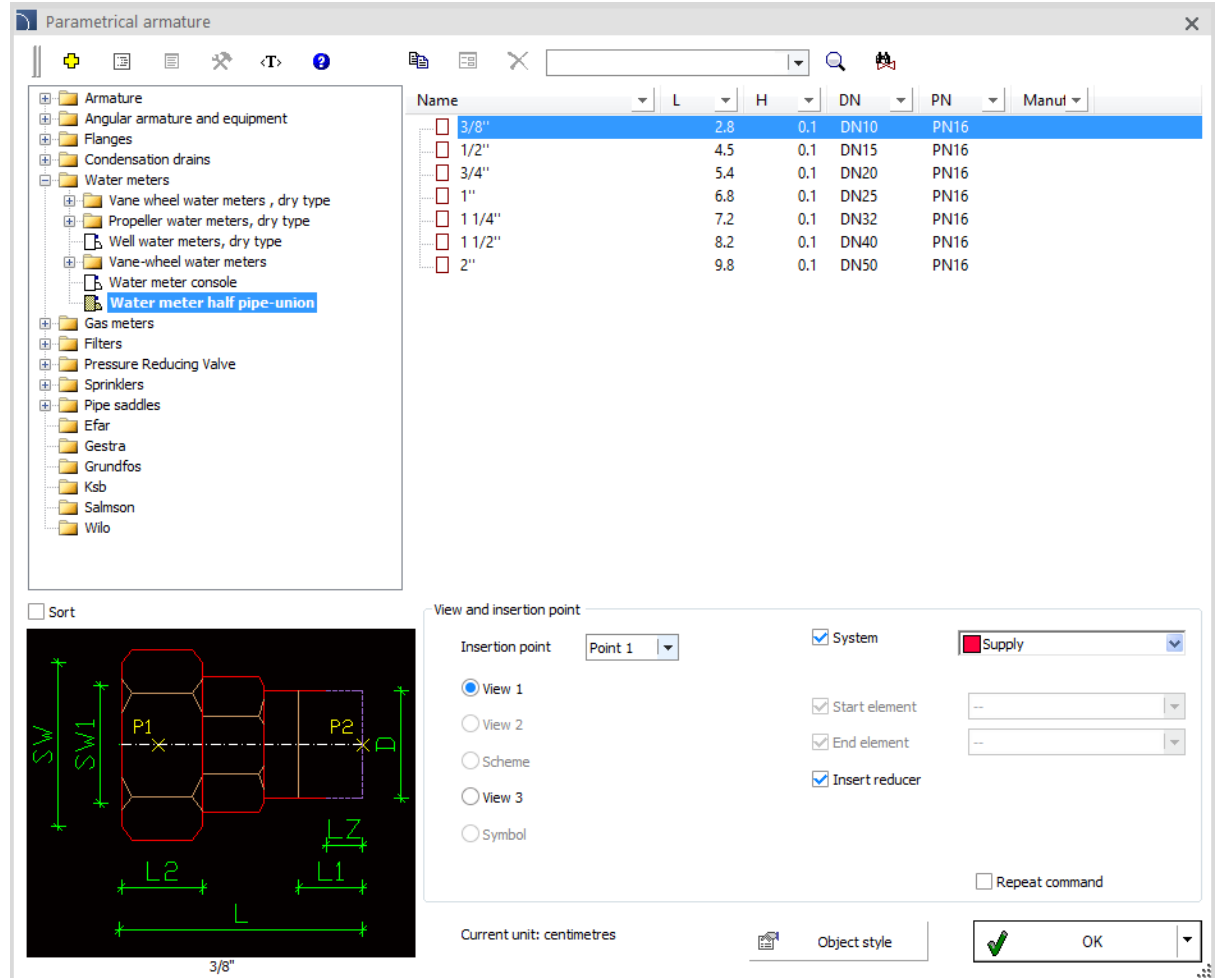

Name	L	H	DN	PN	Manut
3/8"	2.8	0.1	DN10	PN16	
1/2"	4.5	0.1	DN15	PN16	
3/4"	5.4	0.1	DN20	PN16	
1"	6.8	0.1	DN25	PN16	
1 1/4"	7.2	0.1	DN32	PN16	
1 1/2"	8.2	0.1	DN40	PN16	
2"	9.8	0.1	DN50	PN16	

View and insertion point

Insertion point: Point 1

System: Supply

Start element: --

End element: --

Insert reducer

Repeat command

Current unit: centimetres

Object style:  OK

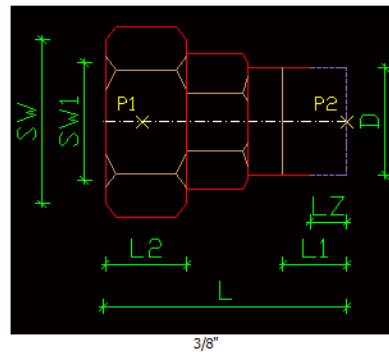

✓ CADprofi HVAC & Piping – extension of KORADO radiators library

New heaters have been added to Korado library, including:

- RADIK KLASIK-R (panel heater).
- RADIK CLEAN (flat panel heater).
- RADIK CLEAN-VK (flat panel heater with thermostatic valve).

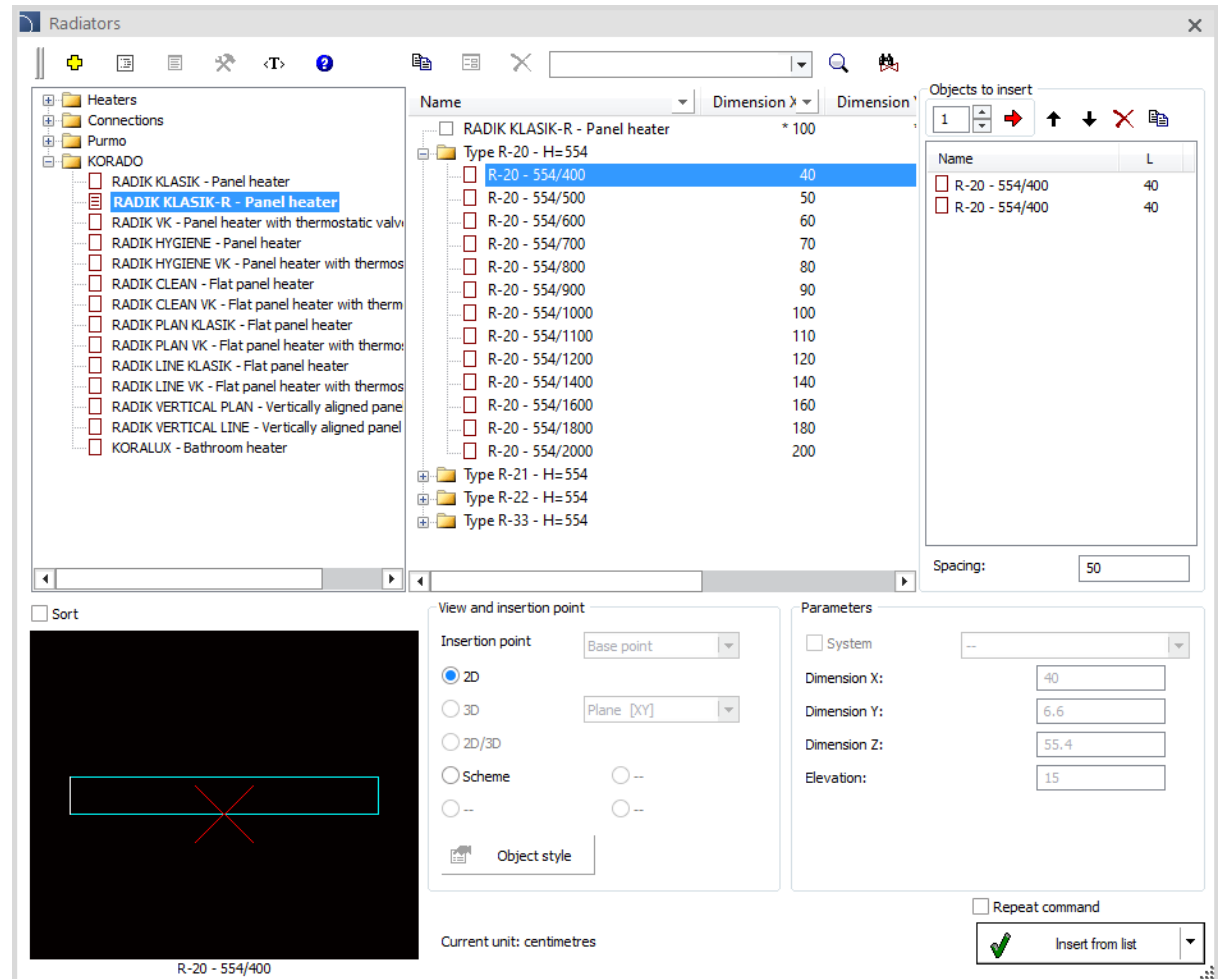

✓ Update of BCS library

The library of the BCS company supports the design of IP video monitoring installations.

In the latest version of CADprofi, the BCS library has been updated with new products, including:

BCS LINE:

- IP video recorders (4, 8, 16, 32, 64, 128 channels).
- IP cameras (box, bullet, dome, PTZ, fisheye).
- ANPS cameras
- Panoramic cameras.
- Thermo cameras.
- Keyboards.

BCS Point:

- IP video recorders (4, 8, 16, 32, 64 channels).
- IP cameras (bullet, dome, PTZ, box).

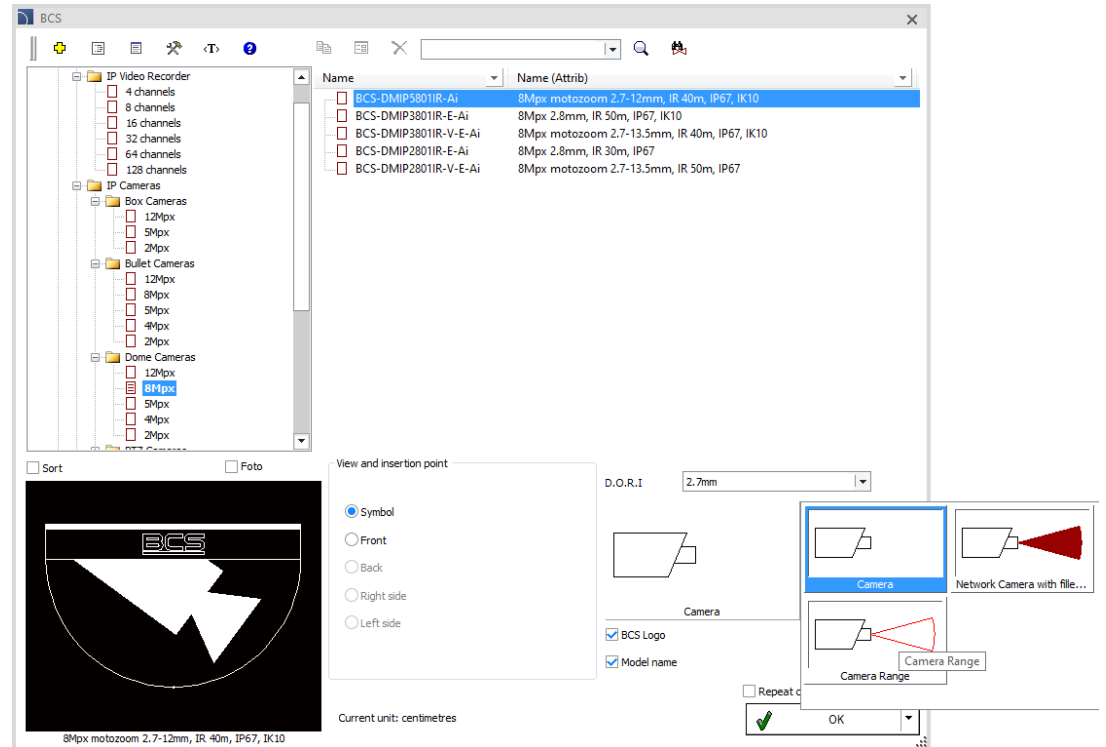



CADprofi

✓ Update of manufacturers' libraries:





CADprofi

✓ Adjustment to many base CAD programs

CADprofi 2021.07 has been adjusted to work with latest CAD programs, including: IBS CAD 2021 and ArCADia 12.1.

CADprofi 2021 currently works with many base CAD programs including: AutoCAD (since the 2000 version), BricsCAD, GstarCAD, IntelliCAD, progeCAD, ZWCAD, ARES Commander Edition and others.

The logo for AutoCAD, with the word "AutoCAD" in a bold, red, sans-serif font.

The logo for ZWCAD, with "ZW" in blue and "CAD" in a larger blue font, and a green leaf-like graphic above the "W".

The logo for GstarCAD, with "Gstar" in blue and "CAD" in yellow, and the tagline "An Alternative CAD System" in blue below it.

The logo for BricsCAD, featuring a stylized blue "B" shape above the word "BRICSCAD" in a bold, black, sans-serif font.

The logo for progeSOFT, featuring a blue globe with a yellow vertical bar and a yellow triangle above it, with the text "progeSOFT" below.

The logo for IntelliCAD, featuring a purple diamond shape with a yellow vertical bar and a yellow triangle above it, with the text "IntelliCAD" below.

The logo for Gräbert ARES Commander, featuring a red stylized flame or wing graphic to the left of the text "Gräbert ARES® Commander".



CADprofi



CADprofi 2021.05

✓ CADprofi Architectural – drawing walls with insulation

Drawing walls with filled insulation has been added to CADprofi Architectural.

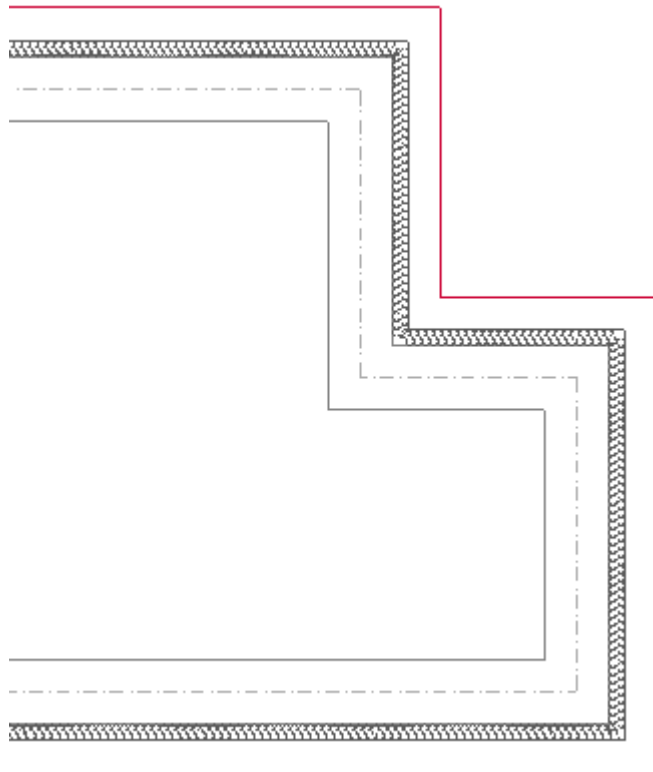

Walls
✕

+ 📄 📄 ★ ✕ <T> 🌐 ➔ || ↑ ↓ ✕ 📄 💾 🗑️

Pick distance

- Walls by material
 - Examples
 - Concrete
 - Bricks
 - Clinker
 - Air-brick
 - Gypsum plasterboard
 - HPL plate
 - Expanded polystyrene
 - Mineral wool
 - Insulating foam
 - Polyurethane insulation
 - Walls by purpose
 - Examples
 - Load-bearing wall
 - Wall installation
 - Curtain wall
 - Plate partition wall
 - External plaster
 - Air space
 - Thermal insulation
 - Moisture insulation
 - Acoustic insulation
 - Cold Insulation

Main	Name	Layer	Line type	Thickness
<input checked="" type="checkbox"/>	Concrete	2DA_WAL_C...	Continuous	240
<input type="checkbox"/>	Insulating foam	2DA_WAL_Pia	Continuous	60
<input type="checkbox"/>	Clinker	2DA_WAL_Cli	Continuous	120

Draw symmetry axis of main wall layer

Edge of drawing and offset

left
 center
 right
 symmetry axis of main layer

Offset:

Match walls in layouts

Check insulation width

Current unit: millimetres

Sort

Separate "User" category

OK

✓ CADprofi Electrical – extension of the fire protection symbols library

The following symbols have been added to the library of fire protection system:

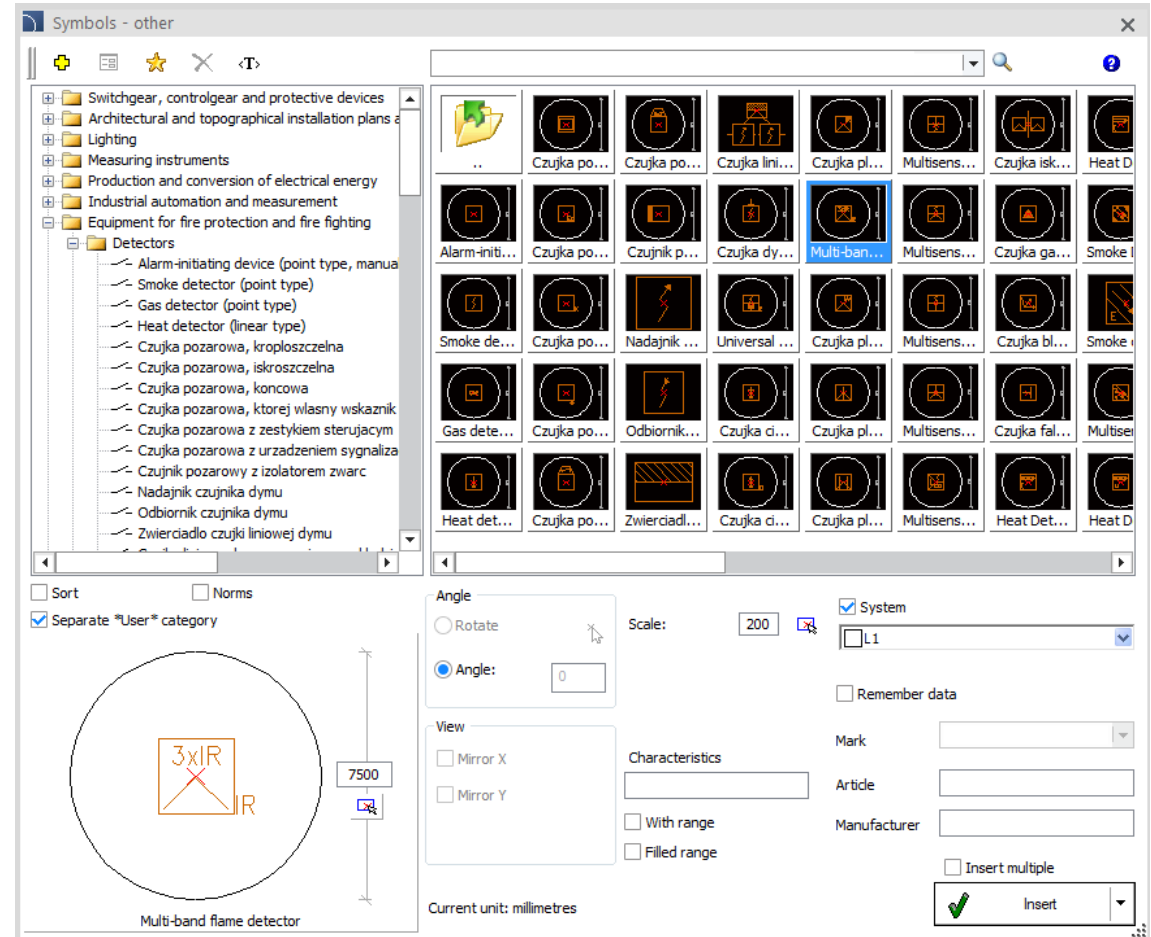

- Button for ventilation, smoke exhaust, and extinguishing control.
- Service transmitter.
- Rain / wind sensor.
- Vent switch with key.
- Aspirating detector.
- Ceiling speaker, wall mounted.
- Power supply for fire signaling and automation.
- Multi-band IR flame detector.
- Radio smoke detector.
- Adapter for radio detectors, side line.
- Parallel signaling terminal.
- Manual call point.
- Monitoring and steering element, multi-output control, multi-input control.
- Addressable acoustic, tone and voice signaling device.



✓ CADprofi HVAC & Piping – extension of the household appliances symbol library

Additional symbols for gas appliances have been added to the program, including:

- Gas stove (2, 4, 6, 8 burner).
- Portable gas stove (2, 3, 4 burner).
- Gas heating stool (1, 2, 3 burner).
- Gas bakery oven.
- Gas oven for pizza.

Additional symbols are available in the *Symbols*  and *Plumbing objects - Plan*  commands.

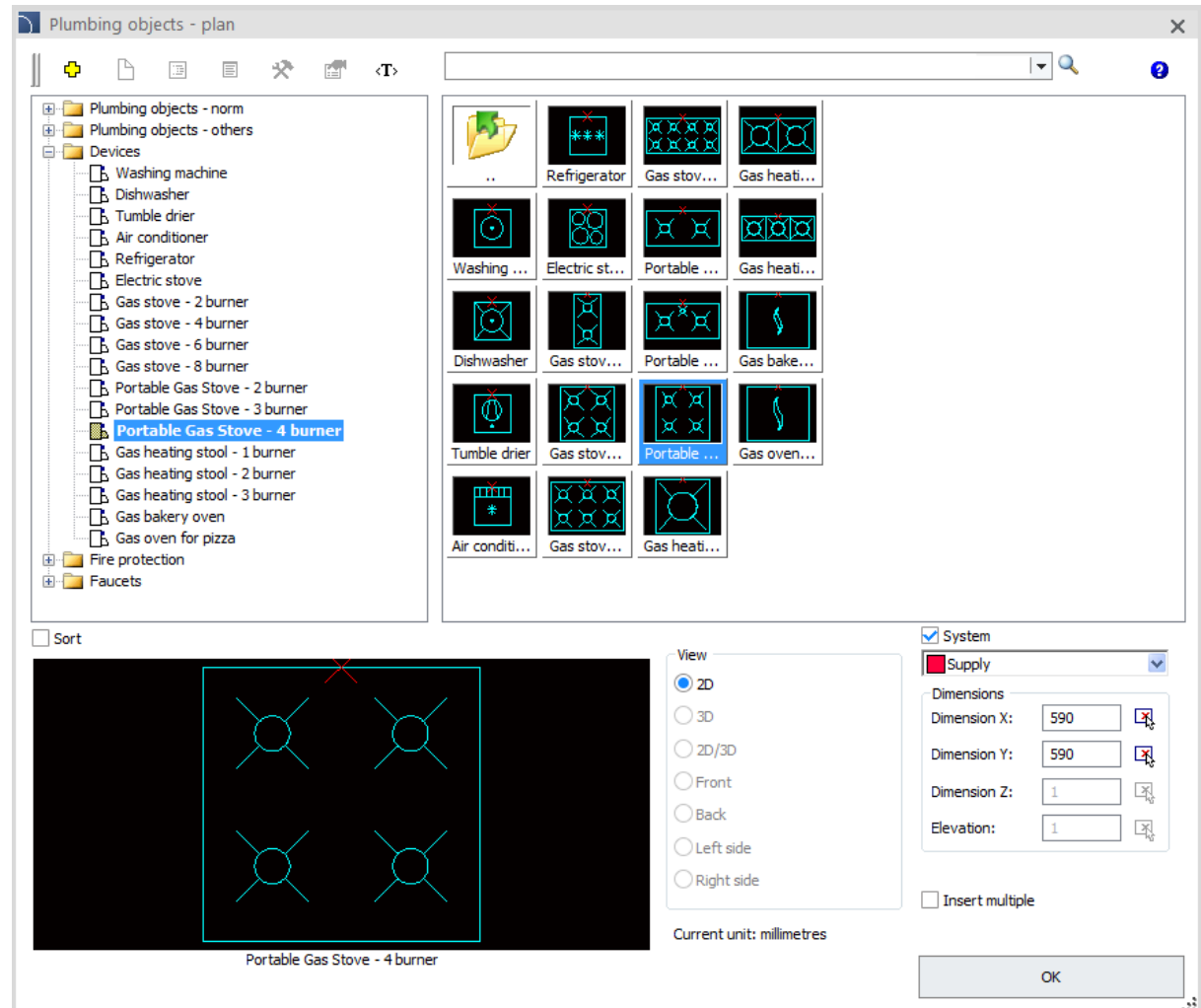

✓ Extension of ABB library – electrical schemes

The ABB library available in CADprofi has been extended with example electrical diagrams of control systems for frequency converters.

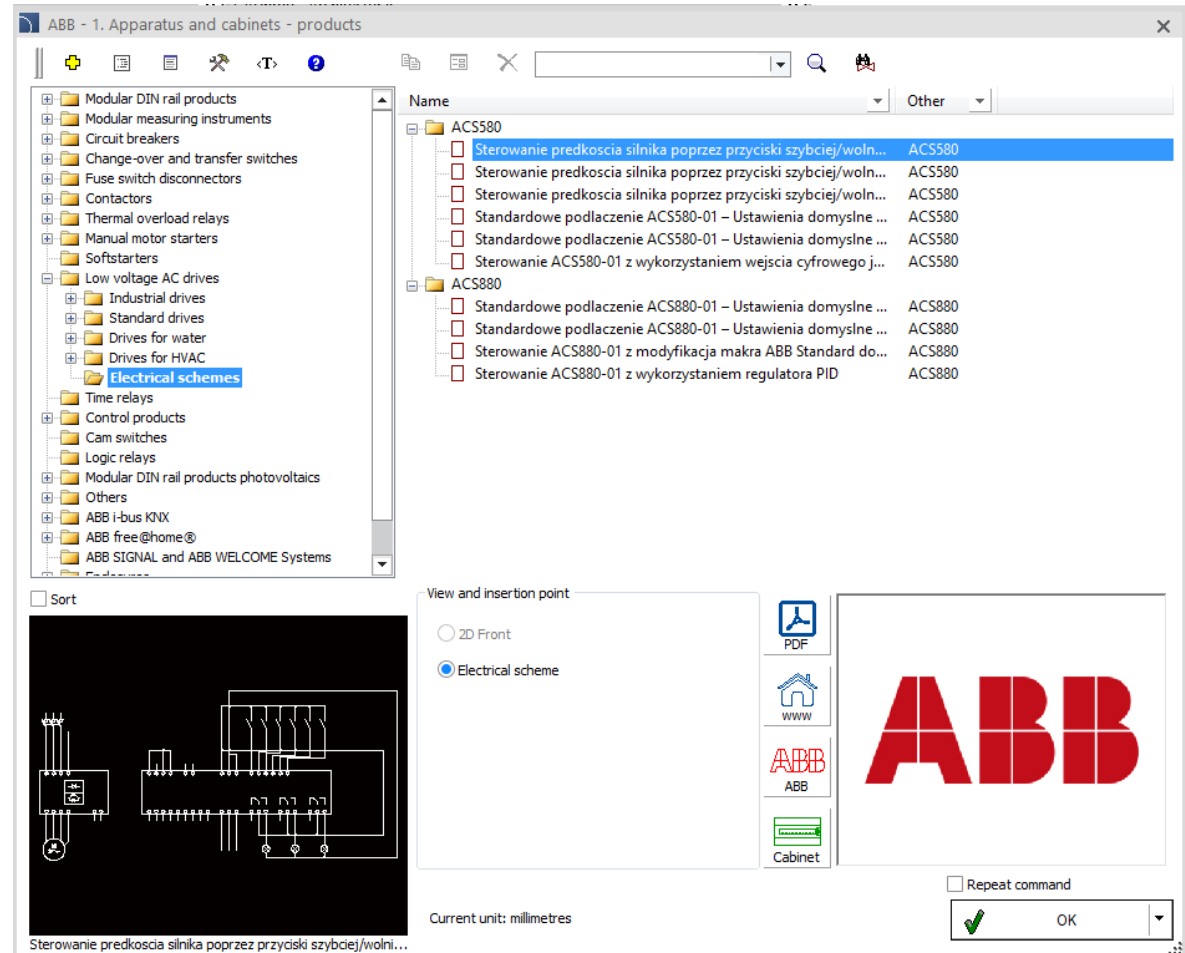
The screenshot displays the CADprofi software interface with the ABB library extension. The left sidebar shows a tree view of product categories, with 'Electrical schemes' highlighted. The main window shows a list of electrical schemes, including ACS580 and ACS880 series. The bottom panel shows a preview of an electrical diagram for a motor speed control system, with the ABB logo and navigation icons (PDF, www, ABB, Cabinet) visible. The current unit is set to millimetres, and the 'Repeat command' checkbox is checked.

ABB - 1. Apparatus and cabinets - products

Modular DIN rail products
 Modular measuring instruments
 Circuit breakers
 Change-over and transfer switches
 Fuse switch disconnectors
 Contactors
 Thermal overload relays
 Manual motor starters
 Softstarters
 Low voltage AC drives
 Industrial drives
 Standard drives
 Drives for water
 Drives for HVAC
Electrical schemes
 Time relays
 Control products
 Cam switches
 Logic relays
 Modular DIN rail products photovoltaics
 Others
 ABB i-bus KNX
 ABB free@home®
 ABB SIGNAL and ABB WELCOME Systems

Name Other

ACS580
 Sterowanie predkoscia silnika poprzez przyciski szybkiej/woln... ACS580
 Sterowanie predkoscia silnika poprzez przyciski szybkiej/woln... ACS580
 Sterowanie predkoscia silnika poprzez przyciski szybkiej/woln... ACS580
 Standardowe podlaczenie ACS580-01 – Ustawienia domyslne ... ACS580
 Standardowe podlaczenie ACS580-01 – Ustawienia domyslne ... ACS580
 Sterowanie ACS580-01 z wykorzystaniem wejścia cyfrowego j... ACS580

ACS880
 Standardowe podlaczenie ACS880-01 – Ustawienia domyslne ... ACS880
 Standardowe podlaczenie ACS880-01 – Ustawienia domyslne ... ACS880
 Sterowanie ACS880-01 z modyfikacja makra ABB Standard do... ACS880
 Sterowanie ACS880-01 z wykorzystaniem regulatora PID ACS880

Sort

View and insertion point
 2D Front
 Electrical scheme

PDF
 www
 ABB
 ABB
 Cabinet

Repeat command
 OK

Current unit: millimetres

Sterowanie predkoscia silnika poprzez przyciski szybkiej/woln...

✓ Update of Elko-Bis library

The Elko-Bis library available in CADprofi has been updated with new masts with the specified maximum wind resistance parameter.

The possibility of attaching accessories to the masts (adjustment kits, washers, support bars, etc.) have also been added to the program.

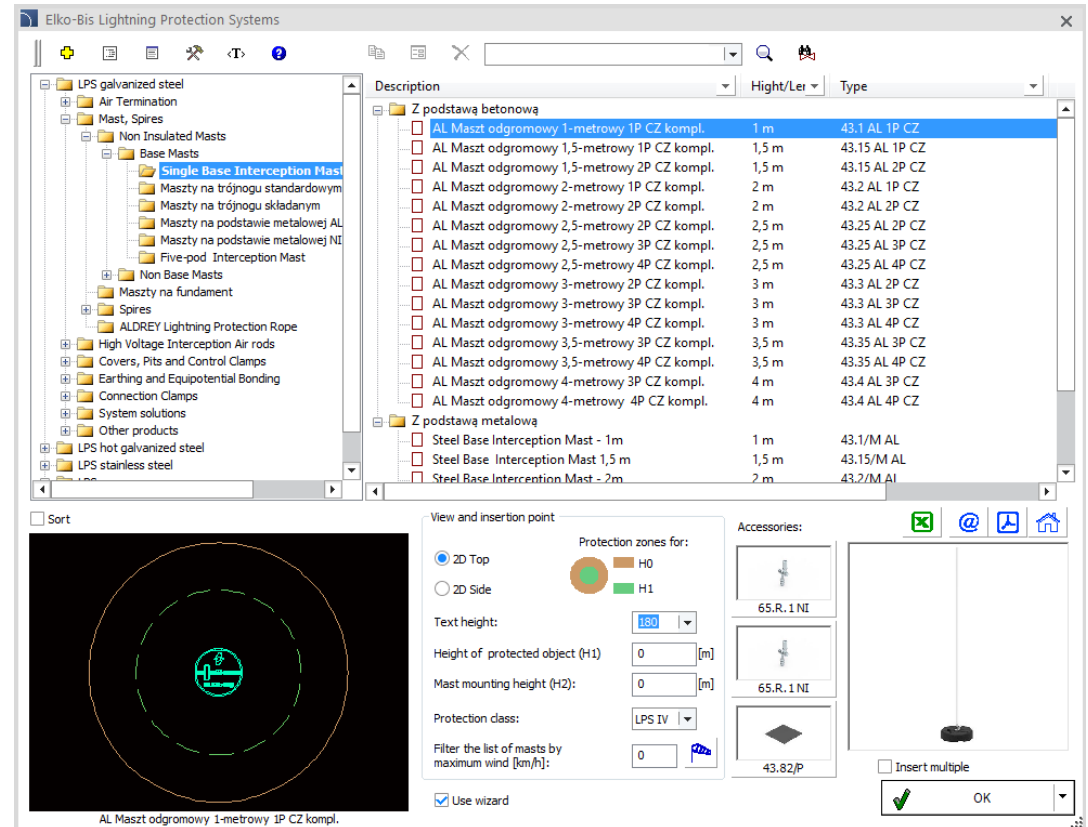



CADprofi

✓ **Update of manufacturer libraries**





CADprofi

✓ Adjustment to many base CAD programs

CADprofi 2021.05 has been adjusted to work with latest CAD programs, including: AviCAD 2021, CADian 2021, CADdirect 2022, CADopia 21, CADMATE 2020 and SilicaCAD 2021.

CADprofi 2021 currently works with many base CAD programs including: AutoCAD (since the 2000 version), BricsCAD, GstarCAD, IntelliCAD, progeCAD, ZWCAD, ARES Commander Edition and others.

The logo for AutoCAD, with "AutoCAD" in red and a registered trademark symbol.

The logo for ZWCAD, with "ZWCAD" in blue and a green leaf-like shape above the "W".

The logo for GstarCAD, with "GstarCAD" in blue and yellow, and the tagline "An Alternative CAD System" below it.

The logo for BricsCAD, featuring a stylized blue "B" shape above the text "BRICSCAD".

The logo for progeSOFT, featuring a blue globe with a yellow vertical bar and a triangle, above the text "progeSOFT".

The logo for IntelliCAD, featuring a purple diamond shape with a yellow vertical bar and a triangle, above the text "IntelliCAD".

The logo for Gräbert ARES Commander, featuring a red stylized flame or wing shape to the left of the text "Gräbert ARES® Commander".



CADprofi



CADprofi 2021

Summary of main changes made to the program since the CADprofi 2020.01 version.



CADprofi

Table of contents:

- [General commands \(affects all modules\)](#)
- [CADprofi Architectural](#)
- [CADprofi Electrical](#)
- [CADprofi Mechanical](#)
- [CADprofi HVAC & Piping](#)
- [Manufacturers libraries](#)
- [Adjustment to CAD programs](#)



CADprofi

✓ Program optimization and acceleration

In the current version of the program, many code optimizations have been introduced, thanks to which the opening of dialog boxes with symbol libraries has been accelerated several times, and additionally some CADprofi commands have been significantly accelerated (e.g. isolating 2D fittings, inserting flanges into 2D fittings, generating energy distribution diagrams). The code optimization affects CAD programs based on the arx/zrx /grx/brx technology.

In some commands, additional options have been introduced, e.g. the ability to specify any block names (when adding symbols to the program yourself), the ability to lock the scaling of symbols in graphic legends, and others.

The ability to determine the location of objects has been added to the system of creating specifications. Specifications can now contain information in which rooms or zones the individual objects are located. This option allows user to define the amount of materials in regard to e.g. housing units.



✓ CADprofi – object placement (command extension)

The *Arrange* command allows user to quickly arrange objects in selected rooms. It is possible to arrange objects in selected rooms, in the indicated boundary (polyline) or in the newly drawn boundary. In the latest version of the program, the command has been extended with the possibility of placing objects:

- in rectangular array,
- along indicated points,
- along line or polyline.



[Watch video](#)

The *Arrange* command significantly speeds up the insertion of fire detectors, sprinklers, lighting and other objects.

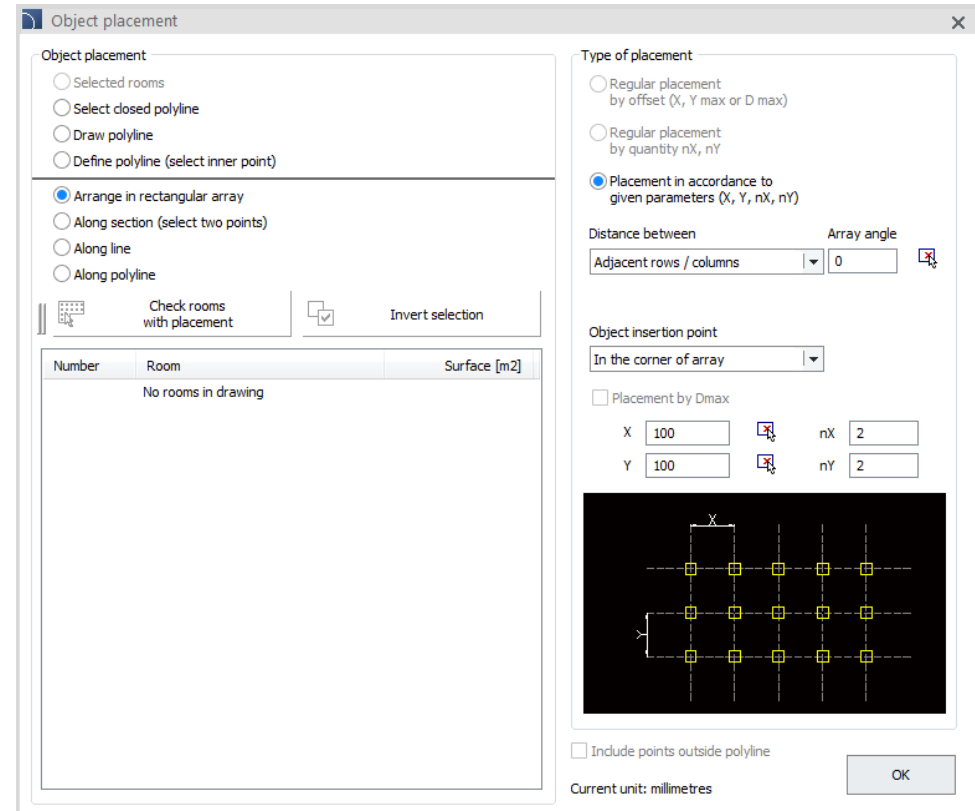

✓ CADprofi – integrated calculations for the central heating and water installations

A completely new schemes generator for decentralized hot water preparation has been introduced in the KaMo library. This generator is integrated with the hydraulic calculations of the central heating system and water installations.

Program functionality:

- Unlimited number of risers and floors..
- Any number of receivers connected to the risers.
- Any branching in the scheme with automatic correction of cable routing..
- Possibility to define the beginning of the scheme on the lower floor or at any point (e.g. on the highest floor if there is a heat source there).
- Possibility to use residential stations that work for the needs of central heating and/or hot water. Typical central heating distributors to which radiators or other receivers are connected (e.g. underfloor heating circuits) can be used instead of stations. Thanks to this, program can be used to design any central heating installations.

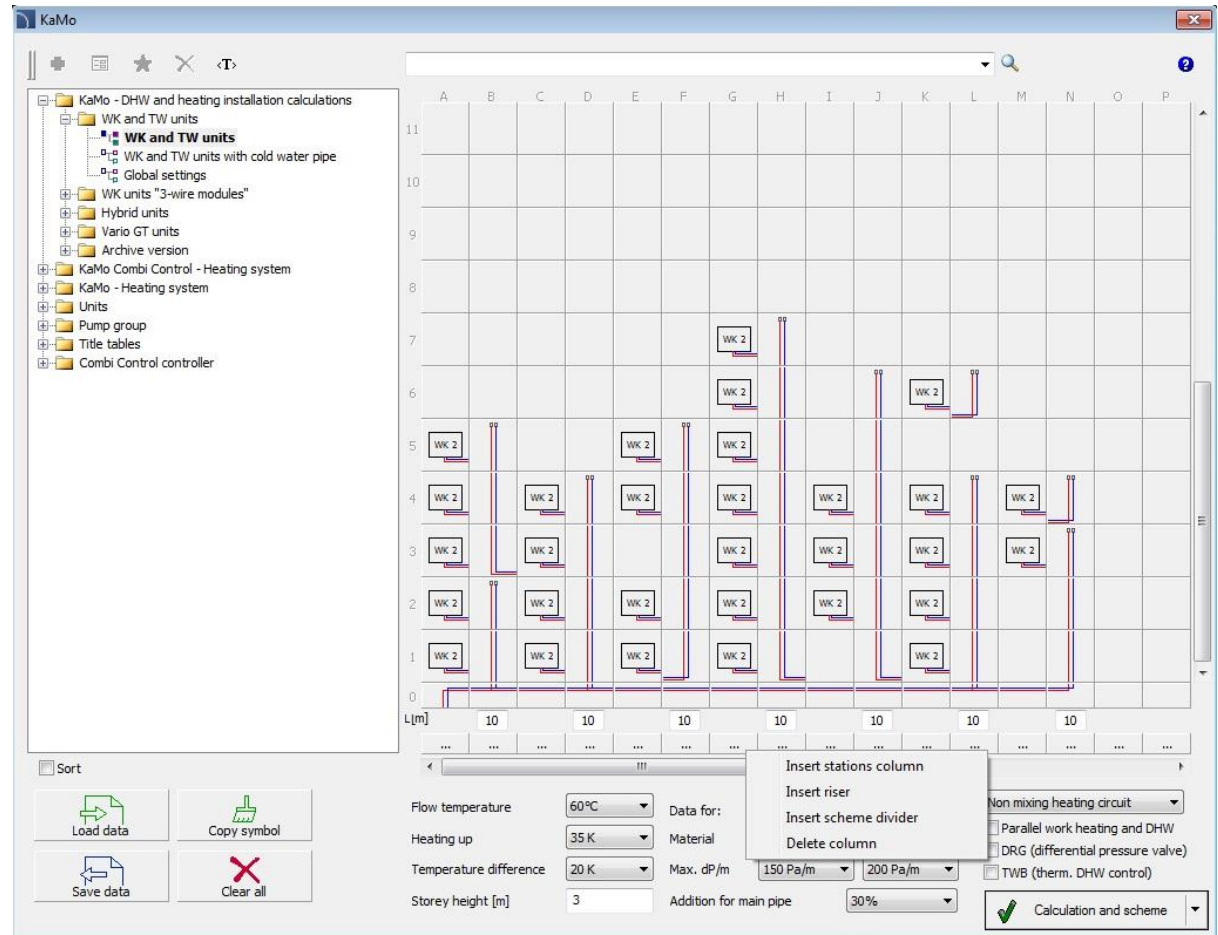

The main window that allows user to conveniently define any scheme

- Auto-complete, copy and delete receiver modes allows user to quickly define the scheme.
- Possibility of designing installations with "three-wire" stations (with common return pipe and separate supply pipes for central heating and hot water).

- Possibility of defining systems consisting of two schemes. It is needed when one heat source works with two heating circuits.
- Automatic selection of pipe diameters.
- Comprehensive hydraulic calculations for central heating with determination of final pressure losses.
- Automatic selection of circulation pumps and buffer charging pump (Wilo or Grundfos).
- Determination of peak power, buffer capacity and required power of the heat source. The parameters of an additional heat source (e.g. heat pumps or solar panels) are taken into account.
- Automatic selection of housing stations based on the DHW capacity or after determining the type and quantity of sanitary utensils that will be attached to the station.
- Automatic recalculation and re-selection of home stations when the installation operating parameters change (e.g. when the flow temperature changes).
- Calculation of the cold water system with the selection of optimal pipe diameters in order to adjust the pressure losses to the available pressure from the water supply network..
- Automatic drawing of scheme with markings of pipe diameters, pressure drops and flows.
- Ability to save projects to files that allows for later editing or creating installation variants (the structure of the project is saved, not the dwg file).
- Inserting tables with technical parameters and calculation results into the drawing.
- Creating specifications with receivers as well as the number and types of pipes (for central heating and water installations).

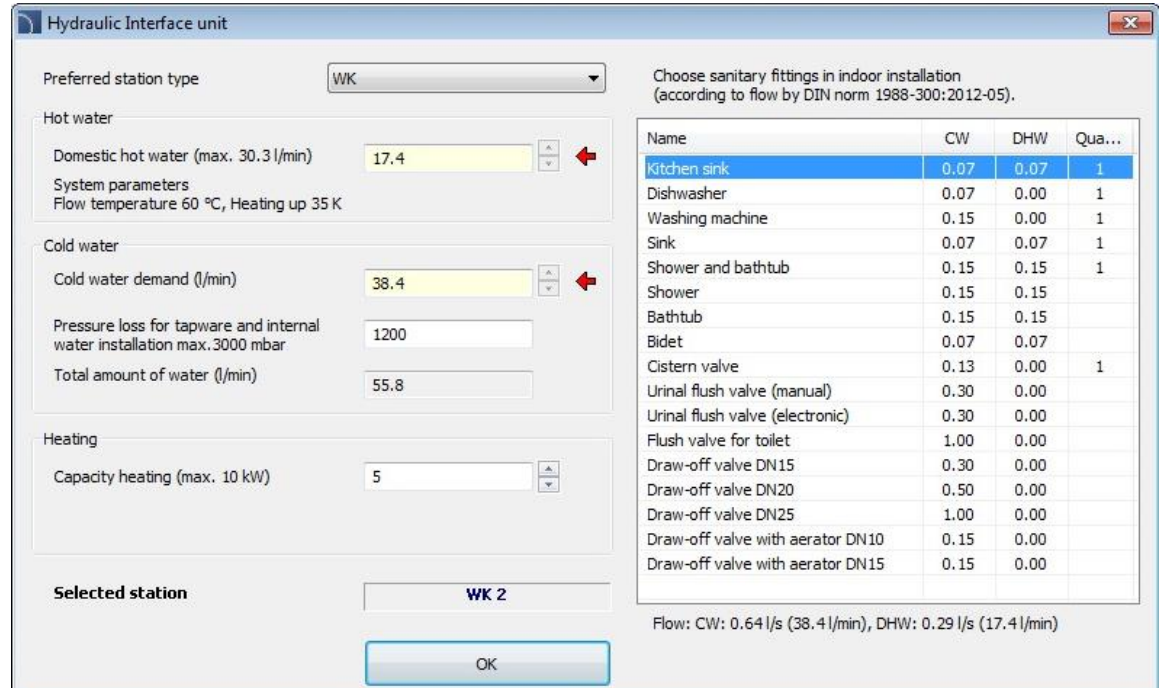

Hydraulic Interface unit

Preferred station type: WK

Hot water

Domestic hot water (max. 30.3 l/min): 17.4

System parameters
Flow temperature 60 °C, Heating up 35 K

Cold water

Cold water demand (l/min): 38.4

Pressure loss for tapware and internal water installation max. 3000 mbar: 1200

Total amount of water (l/min): 55.8

Heating

Capacity heating (max. 10 kW): 5

Selected station: WK 2

Choose sanitary fittings in indoor installation (according to flow by DIN norm 1988-300:2012-05).

Name	CW	DHW	Qua...
Kitchen sink	0.07	0.07	1
Dishwasher	0.07	0.00	1
Washing machine	0.15	0.00	1
Sink	0.07	0.07	1
Shower and bathtub	0.15	0.15	1
Shower	0.15	0.15	
Bathtub	0.15	0.15	
Bidet	0.07	0.07	
Cistern valve	0.13	0.00	1
Urinal flush valve (manual)	0.30	0.00	
Urinal flush valve (electronic)	0.30	0.00	
Flush valve for toilet	1.00	0.00	
Draw-off valve DN15	0.30	0.00	
Draw-off valve DN20	0.50	0.00	
Draw-off valve DN25	1.00	0.00	
Draw-off valve with aerator DN10	0.15	0.00	
Draw-off valve with aerator DN15	0.15	0.00	

Flow: CW: 0.64 l/s (38.4 l/min), DHW: 0.29 l/s (17.4 l/min)

OK

Window for hot water preparation station selection and determination of calculation flows

Scheme fragment:

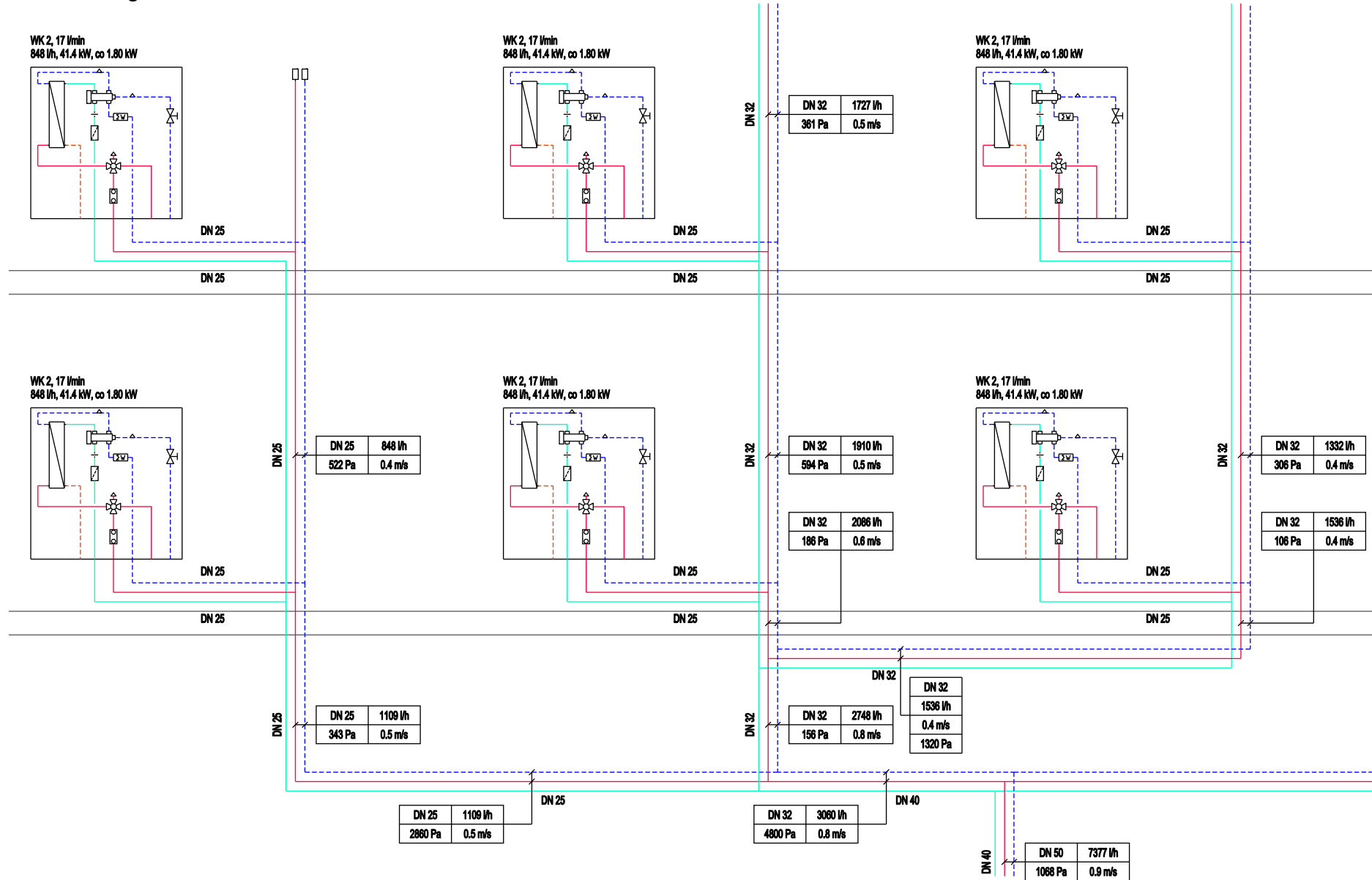

Sample printout with central heating calculations

Heat exchanger type	Number apartme	Section	Simultar DHW producti	Simultan heating	Volume flow DHW production [l/h]	Capacity heating [kW]	Volume flow heating [l/h]	Total volume flow [l/h]	DN	R * l [Pa]	v [m/s]	Z [Pa]	Pressure loss [Pa]
Riser Nr. 7 (apartment on top of another) (N3)													
M3: WK 2, 17 l/min, 848 l/h, 41.4 kW, HZ 1.80 kW	1	Section A 1 (N3)	1.000	0.000	848	0.0	0	848	25	$87 * 14.4 = 1253$	0.41	82	1335
N0: Supply line	1	Section Z 1 (N0)	1.000	0.000	848	0.0	0	848	25	$87 * 20.0 = 1740$	0.41	206	1946

Sum:

3281

Riser Nr. 4 (apartment on top of another) (H7)

G7: WK 2, 17 l/min, 848 l/h, 41.4 kW, HZ 1.80 kW	1	Section A 2 (H7)	1.000	0.000	848	0.0	0	848	25	$87 * 6.0 = 522$	0.41	82	604
G6: WK 2, 17 l/min, 848 l/h, 41.4 kW, HZ 1.80 kW	2	Section A 3 (H6)	1.237	0.763	1050	1.4	59	1109	25	$143 * 6.0 = 858$	0.53	140	998
G5: WK 2, 17 l/min, 848 l/h, 41.4 kW, HZ 1.80 kW	3	Section A 4 (H5)	1.426	1.574	1210	2.8	122	1332	32	$51 * 6.0 = 306$	0.37	67	373
G4: WK 2, 17 l/min, 848 l/h, 41.4 kW, HZ 1.80 kW	4	Section A 5 (H4)	1.590	2.410	1349	4.3	187	1536	32	$66 * 6.0 = 396$	0.42	89	485
G3: WK 2, 17 l/min, 848 l/h, 41.4 kW, HZ 1.80 kW	5	Section A 6 (H3)	1.738	3.262	1474	5.9	253	1727	32	$82 * 6.0 = 492$	0.47	112	604
G2: WK 2, 17 l/min, 848 l/h, 41.4 kW, HZ 1.80 kW	6	Section A 7 (H2)	1.875	4.125	1590	7.4	320	1910	32	$99 * 6.0 = 594$	0.52	137	731
G1: WK 2, 17 l/min, 848 l/h, 41.4 kW, HZ 1.80 kW	7	Section A 8 (H1)	2.003	4.997	1699	9.0	387	2086	32	$116 * 1.6 = 186$	0.57	164	350
H1: Section (branch)	7	Section A 9 (H1)	2.003	4.997	1699	9.0	387	2086	32	$116 * 20.0 = 2320$	0.57	164	2484

Sum:

6629

✓ CADprofi Architectural – changes in wall drawing

The way of drawing walls has been changed in CADprofi Architectural. Currently, the program allows you to select one of the walls as the main one, which can additionally be drawn with the axis of symmetry.

Another new feature is the ability to draw walls along the symmetry axis of the main wall layer.

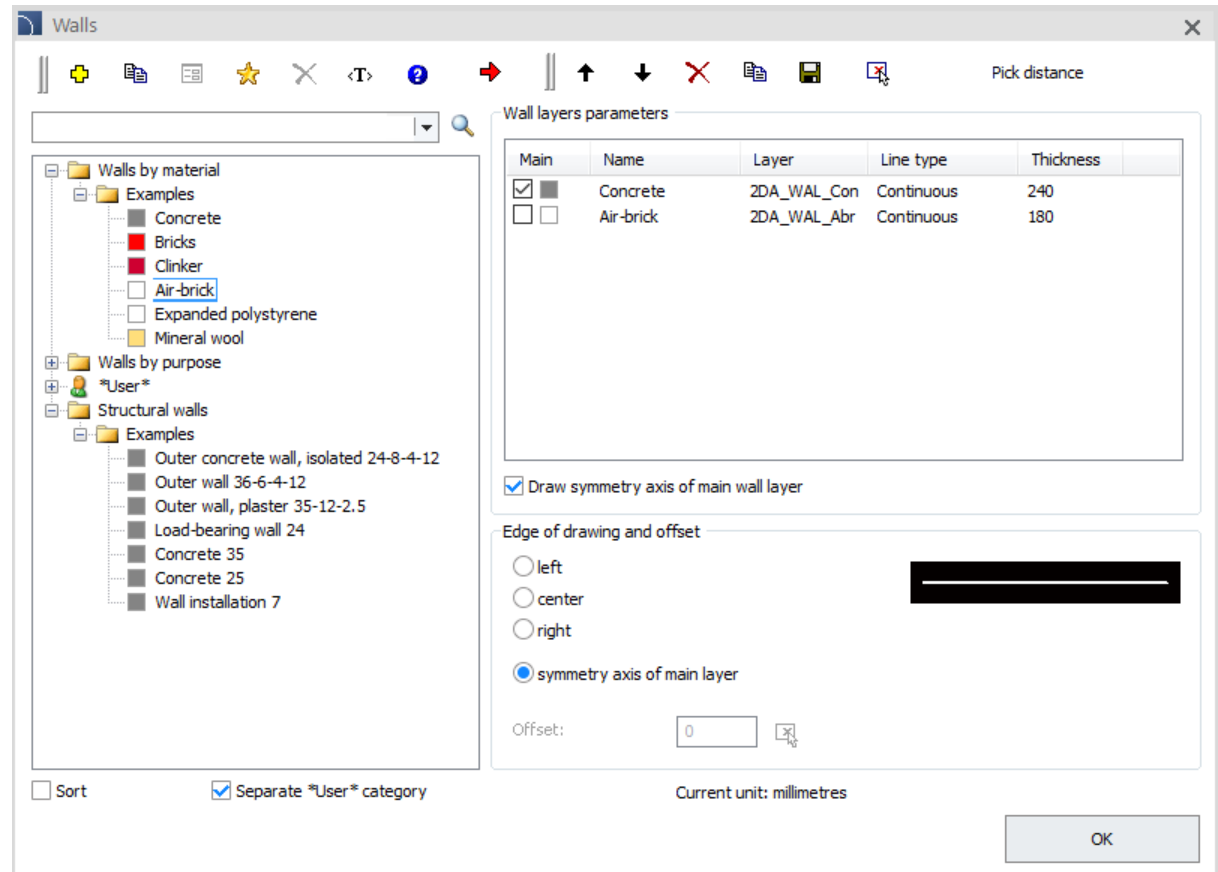





CADprofi

✓ CADprofi Architectural – L and U shape stairs

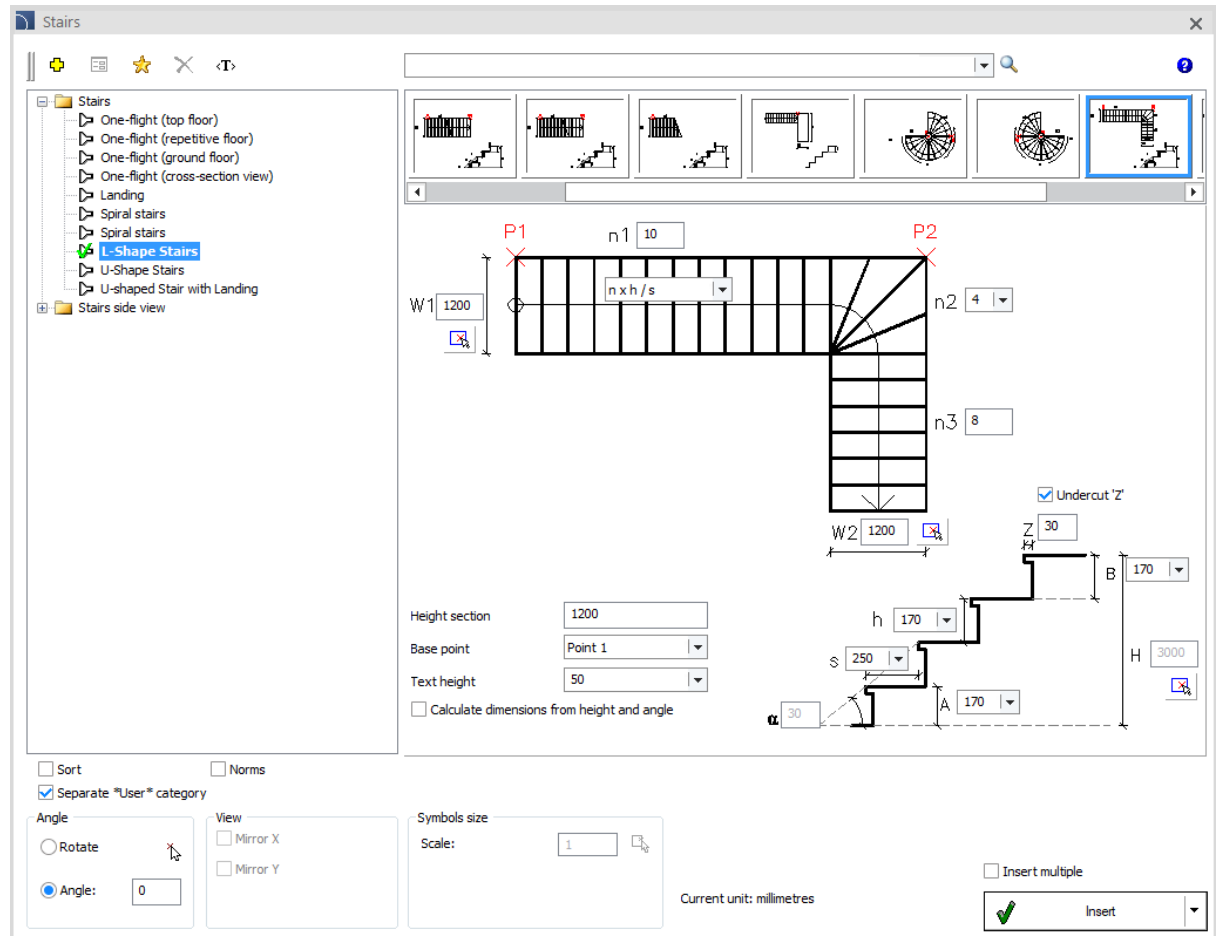
The stair library available in CADprofi Architectural has been extended to include L shape stairs, U shape stairs and U shape stairs with landing.



✓ CADprofi Electrical – changes in busbar and cable trays systems

The *Busbars and cable trays*  commands have been extended.

The busbar library has been extended with additional elements, including heads for switchgears and transformers. Currently, the system includes all the elements necessary to design busbars installations.

Cable trays systems were also added to the command: perforated and non-perforated sheet metal trays, mesh trays and cable ladders.

These systems allow user to make more accurate drawings while specifying accessories (fasteners, connectors, partitions and covers). The ability to specify accessories has also been introduced to the former 2D cable tray system.

Attributes	
Mountings	--
Mountings distance [m]	1.50
Couplers	M8
Quantity of couplers	1
Cover	<input type="checkbox"/>
Divider	0
Material	Aluminium

All accessories are included in the bill of materials.

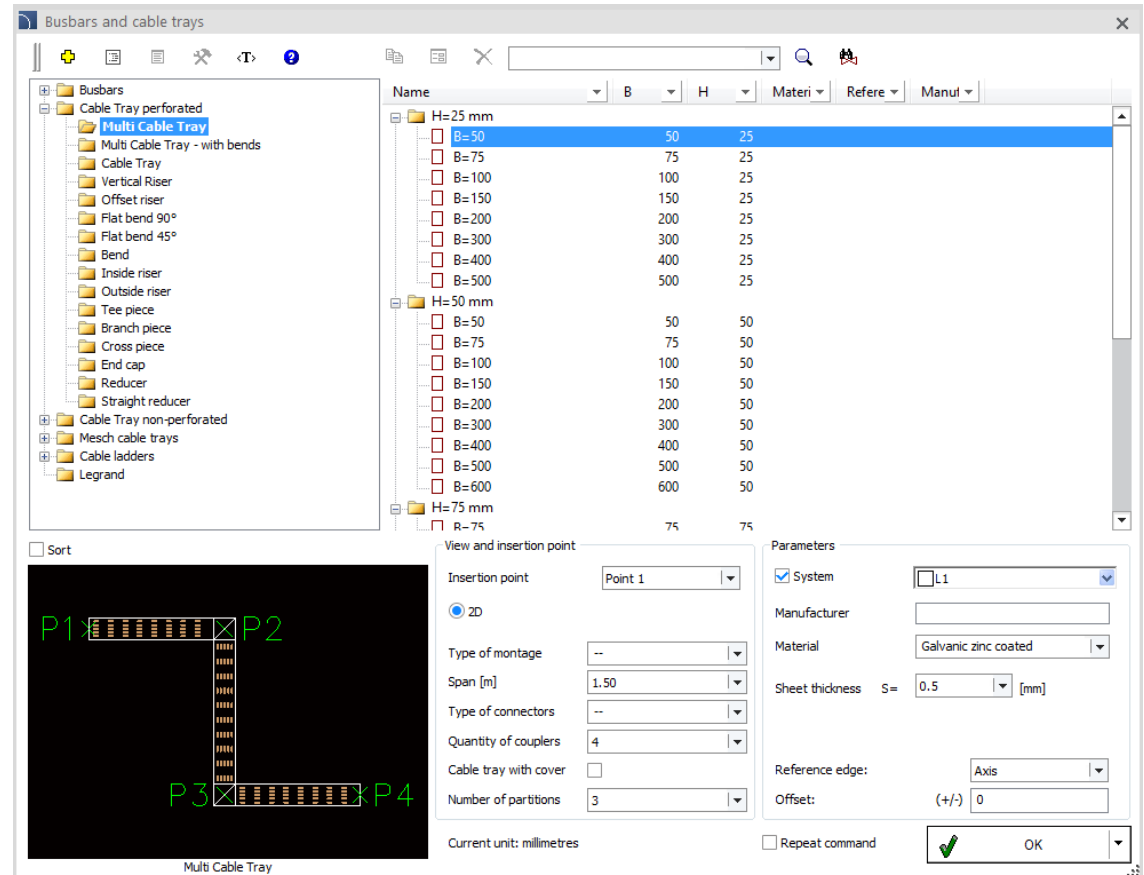

The library is parametric, so by simply entering any dimensions, the library can be independently extended by users with additional types and sizes. As a result, system components from any manufacturer can be used in projects.

✓ CADprofi Electrical – fire alarm control panels

The switchgear library available in CADprofi Electrical has been extended with fire alarm control panels from Awex, Bosch, D + H, LST, POLON-ALFA, Satel, and Siemens.

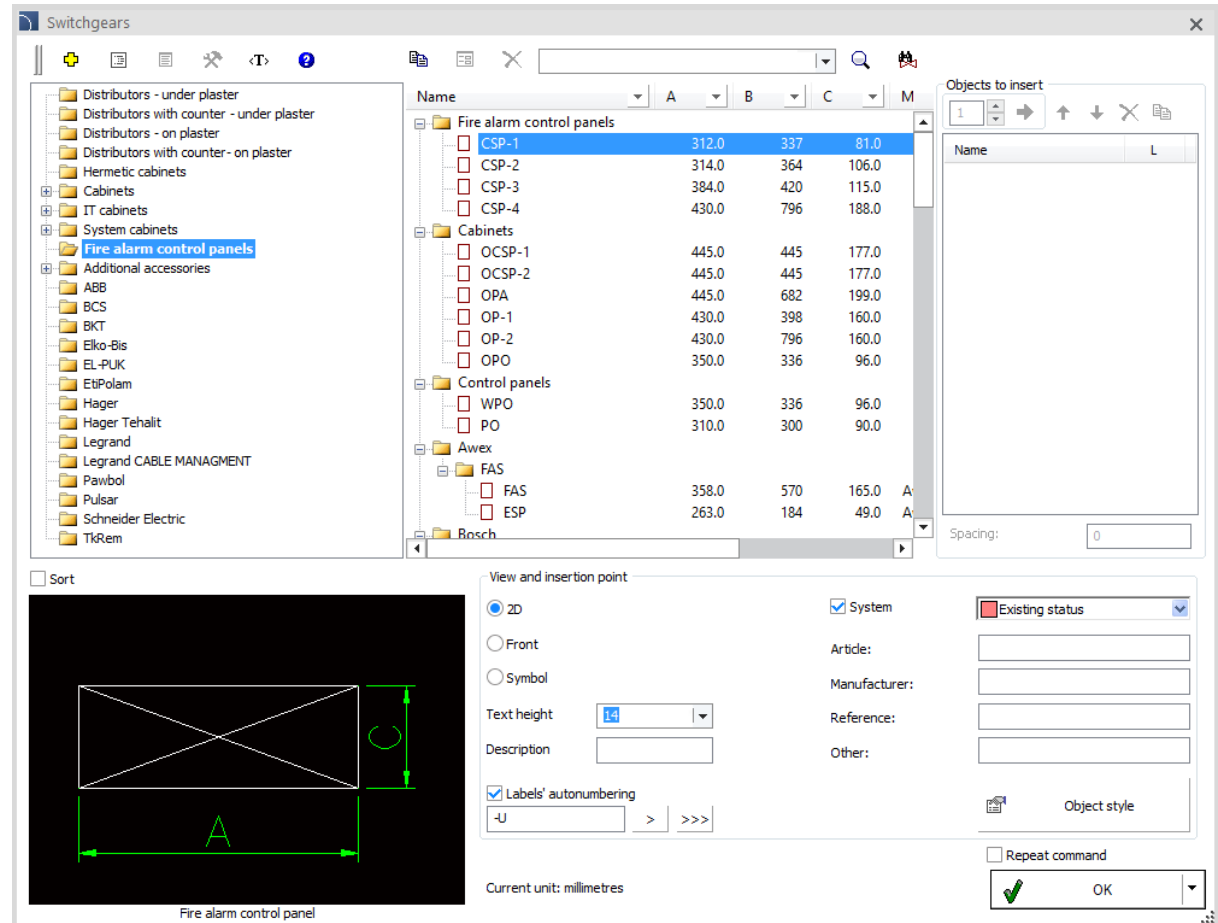

The screenshot displays the CADprofi software interface for managing a library of fire alarm control panels. The main window is titled "Switchgears" and contains a tree view on the left, a central table of components, and a detailed view at the bottom.

Tree View (Left):

- Distributors - under plaster
- Distributors with counter - under plaster
- Distributors - on plaster
- Distributors with counter - on plaster
- Hermetic cabinets
- Cabinets
- IT cabinets
- System cabinets
- Fire alarm control panels**
- Additional accessories
- ABB
- BCS
- BKT
- Elko-Bis
- EL-PUK
- EtPolam
- Hager
- Hager Tehalit
- Legrand
- Legrand CABLE MANAGEMENT
- Pawbol
- Pulsar
- Schneider Electric
- TkRem

Table (Center):

Name	A	B	C	M
Fire alarm control panels				
CSP-1	312.0	337	81.0	
CSP-2	314.0	364	106.0	
CSP-3	384.0	420	115.0	
CSP-4	430.0	796	188.0	
Cabinets				
OCSP-1	445.0	445	177.0	
OCSP-2	445.0	445	177.0	
OPA	445.0	682	199.0	
OP-1	430.0	398	160.0	
OP-2	430.0	796	160.0	
OPO	350.0	336	96.0	
Control panels				
WPO	350.0	336	96.0	
PO	310.0	300	90.0	
Awex				
FAS				
FAS	358.0	570	165.0	A
ESP	263.0	184	49.0	A
Bosch				

Objects to insert (Right):

Name: L

Spacing: 0

View and insertion point (Bottom):

- 2D
- Front
- Symbol
- Text height: 14
- Description: []
- Labels' autonumbering
- U > >>
- Current unit: millimetres
- System
- Article: []
- Manufacturer: []
- Reference: []
- Other: []
- Existing status: []
- Object style: []
- Repeat command
- OK

Diagram (Bottom Left):

A diagram of a fire alarm control panel showing dimensions A and C. The panel is a rectangle with a diagonal cross. Dimension A is the width and dimension C is the height.

Fire alarm control panel

✓ CADprofi Electrical – extension of modular apparatus library

The library of modular apparatus available in CADprofi Electrical has been extended, with two-, three- and four-level terminals, connectors, distribution blocks, arc fault detection devices and arc fault detection devices with integrated RCBO (AFDD).

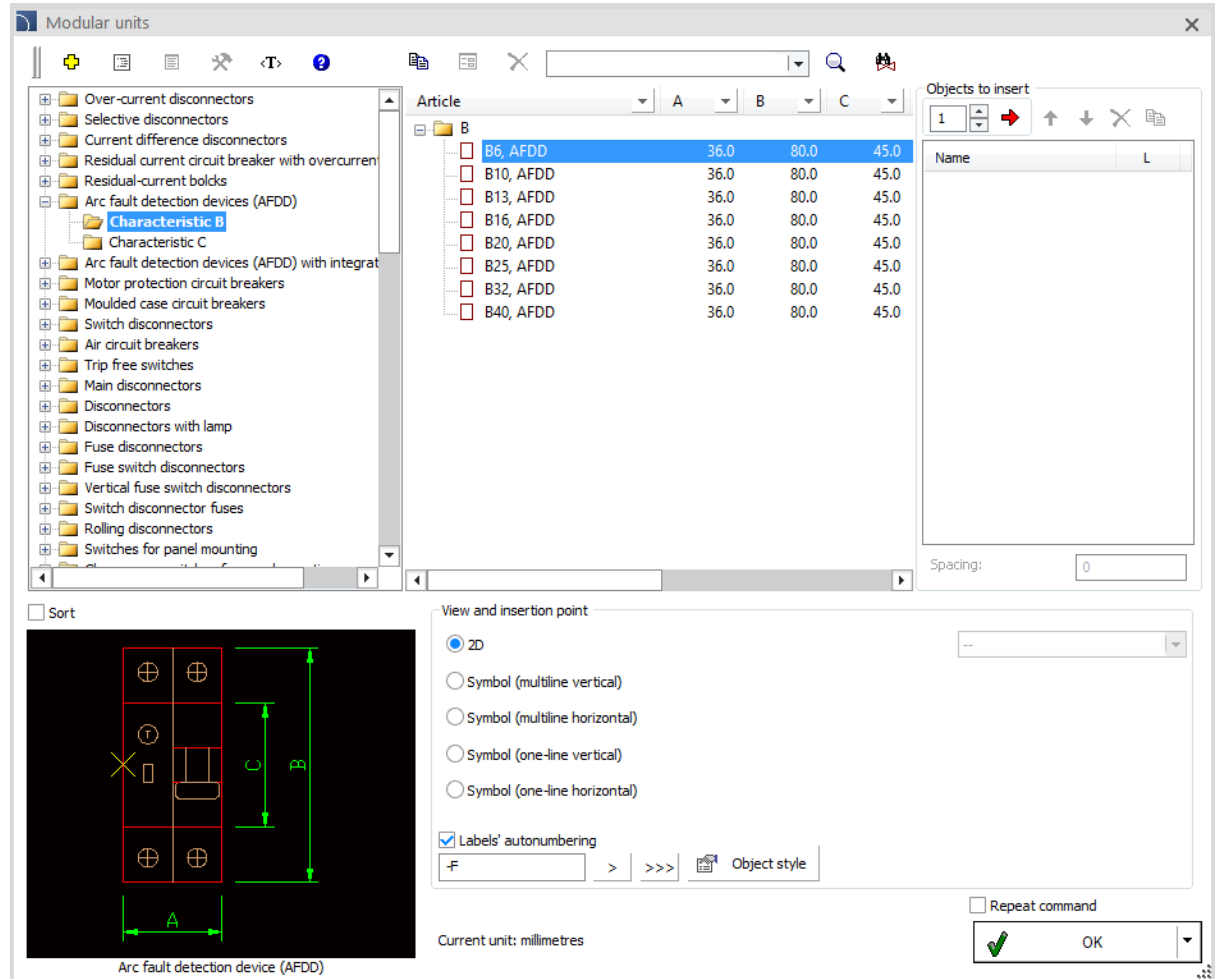

The screenshot displays the 'Modular units' library window in CADprofi Electrical. The left pane shows a hierarchical tree of electrical components, with 'Arc fault detection devices (AFDD)' expanded to show 'Characteristic B' and 'Characteristic C'. The right pane shows a table of articles for 'Characteristic B'.

Article	A	B	C
B6, AFDD	36.0	80.0	45.0
B10, AFDD	36.0	80.0	45.0
B13, AFDD	36.0	80.0	45.0
B16, AFDD	36.0	80.0	45.0
B20, AFDD	36.0	80.0	45.0
B25, AFDD	36.0	80.0	45.0
B32, AFDD	36.0	80.0	45.0
B40, AFDD	36.0	80.0	45.0

Below the table is a preview window showing a 2D symbol for an 'Arc fault detection device (AFDD)'. The symbol is a rectangular block with four terminals (two on the left, two on the right) and a central switch mechanism. Dimensions A, B, and C are indicated with green arrows. The current unit is set to millimetres.

The 'View and insertion point' dialog is open, showing the following options:

- 2D
- Symbol (multiline vertical)
- Symbol (multiline horizontal)
- Symbol (one-line vertical)
- Symbol (one-line horizontal)
- Labels' autonumbering

The 'Labels' field contains '-F'. The 'Object style' button is visible. The 'Repeat command' checkbox is unchecked. The 'OK' button is highlighted with a green checkmark.

✓ CADprofi Mechanical – easy filtering of libraries

All libraries in the Standardized parts and Steel shapes commands have been optimized for convenient filtering, e.g. by dimensions, names, etc.

Once the filter has been added it can apply to the entire library, making it much easier to select the various elements needed to design a given component - for example, selecting bolts, washers, and nuts of a specific diameter.

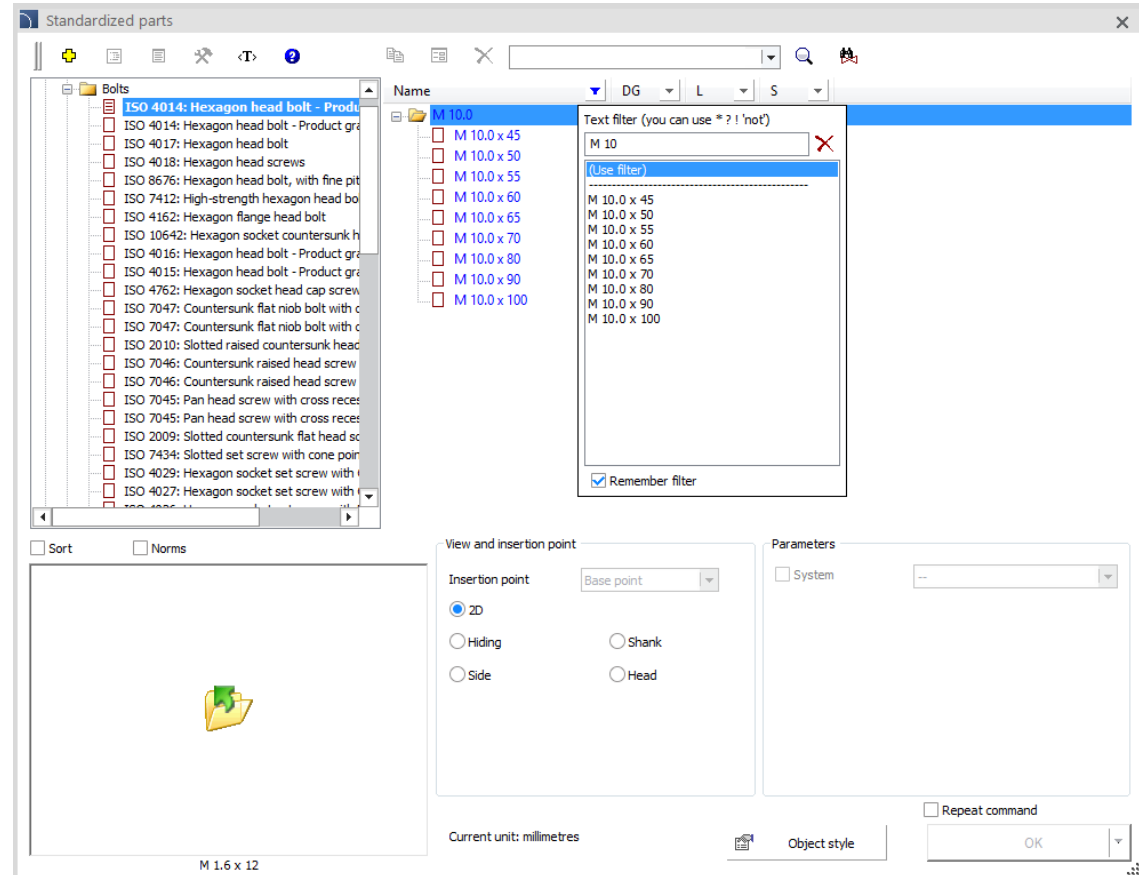

✓ CADprofi Mechanical – library extension including Indian Standards

Program libraries have been extended with additional standards including elements of the Indian Industry Standard (IS):

- Head bolts: hexagonal, cylindrical, square, countersunk, construction bolts, shoulder bolts.
- Rolled head screws.
- Steel shapes (L-Shapes, U-Shapes, I-Shapes).

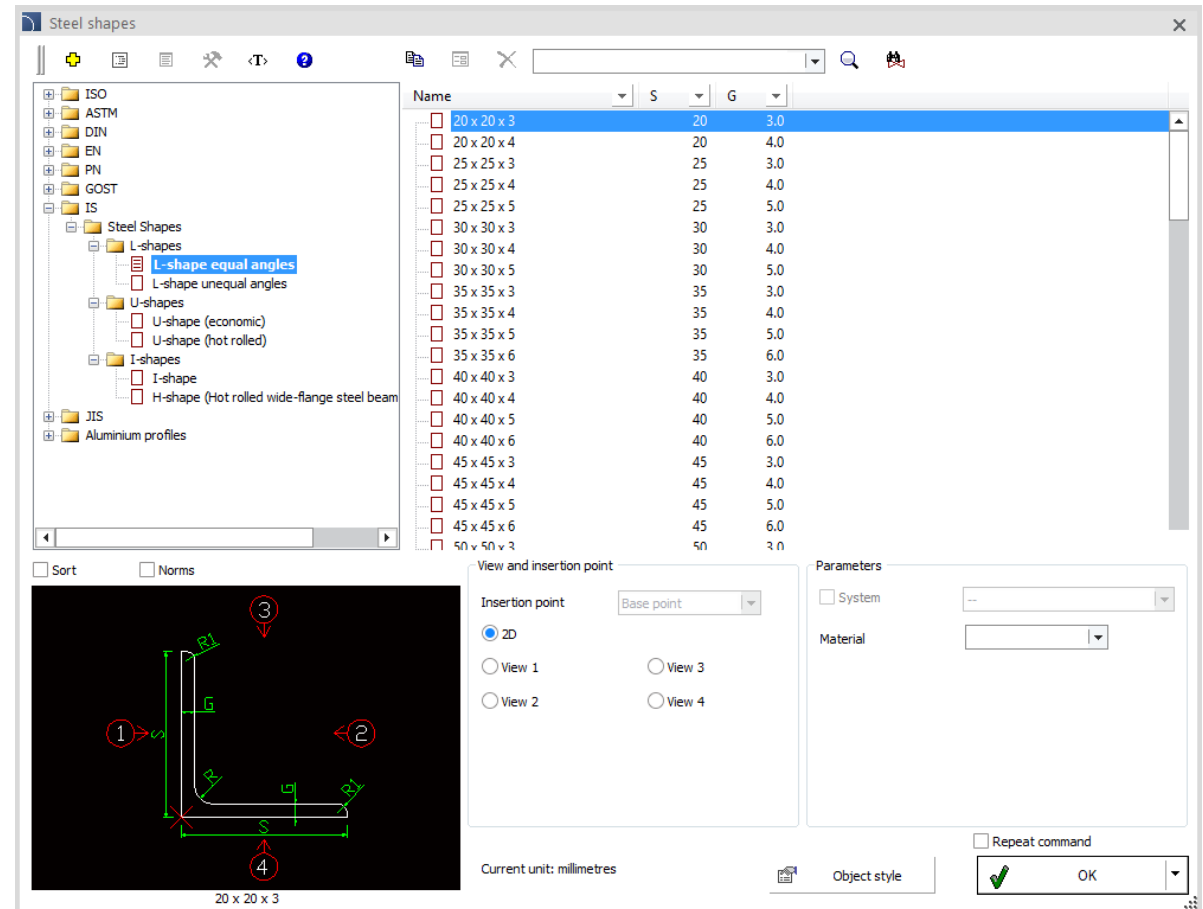



CADprofi

✓ CADprofi HVAC & Piping –Purmo and KORADO radiators

KORADO heaters have been added to CADprofi HVAC & Piping libraries and Purmo heaters have been updated.

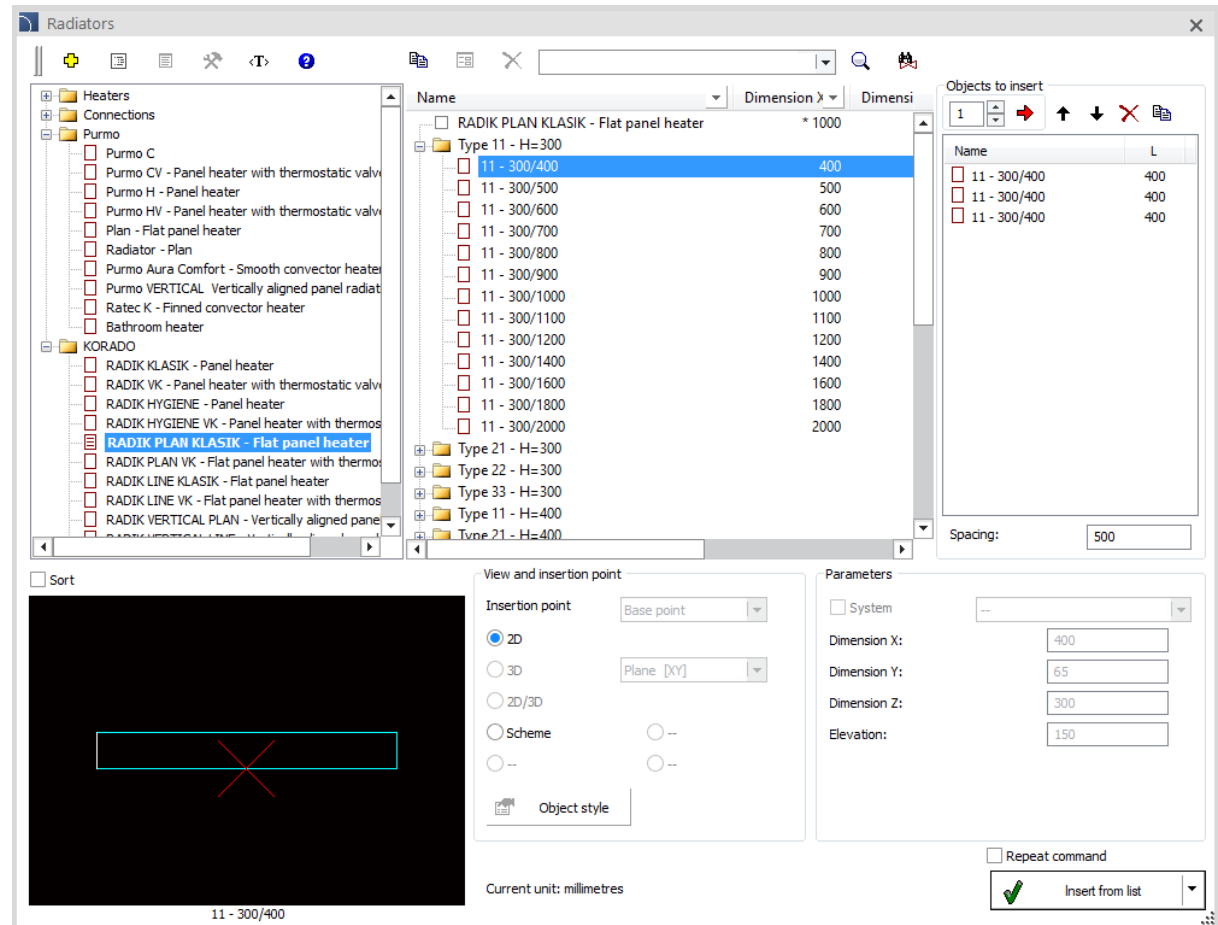



CADprofi

✓ CADprofi HVAC & Piping – HAWLE fittings and Piping system

HAWLE water fittings and piping system in detailed views have been added to CADprofi HVAC & Piping libraries.

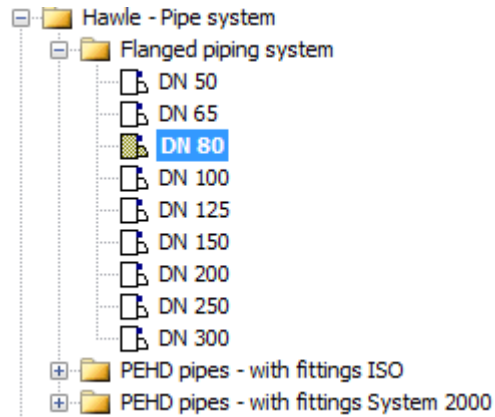

Parametrical armature

Name	L	H	C	PN	Manufac
DN100x80	190	373	220	PN16	
DN125x100	200	450	250	PN16	
DN150x100	210	462	285	PN16	
DN200x150	230	563	340	PN16	
DN250x200	250	670	405	PN16	
DN300x250	270	753	460	PN16	
Hawle-PN16					
4150					
DN100x65	185	328	220	PN16	Hawle
DN100x80	200	336	220	PN16	Hawle
DN125x80	200	336	250	PN16	Hawle
DN125x100	220	373	250	PN16	Hawle
DN150x80	200	336	285	PN16	Hawle
DN150x100	220	373	285	PN16	Hawle
DN200x100	220	373	340	PN16	Hawle
DN200x150	285	462	340	PN16	Hawle
DN250x150	285	462	405	PN16	Hawle
DN250x200	340	563	405	PN16	Hawle
DN300x150	285	462	460	PN16	Hawle
DN300x200	340	563	460	PN16	Hawle
DN300x250	400	563	460	PN16	Hawle

View and insertion point

Insertion point: Point 1

System Supply

View 1 View 2 Scheme View 3 View 4

Start element End element

Insert reducer

Repeat command

Current unit: millimetres

Object style

OK

✓ CADprofi HVAC & Piping – pipe saddles

Pipe saddles have been added to the program, including:

- Pipe saddles for PE and PVC pipes.
- Pipe saddles for steel pipes.
- Armature for pipe saddles.

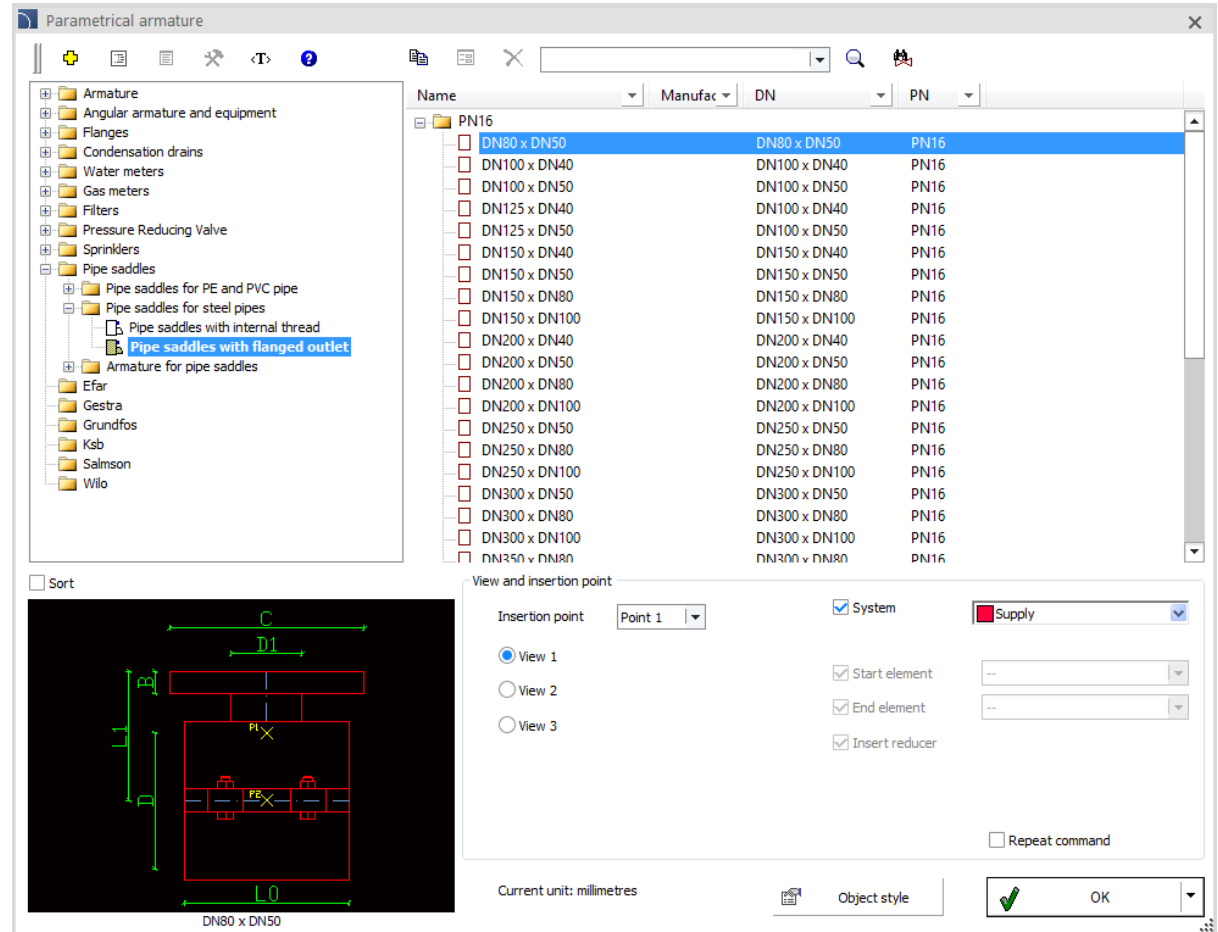

Name	Manufac	DN	PN
DN80 x DN50		DN80 x DN50	PN16
DN100 x DN40		DN100 x DN40	PN16
DN100 x DN50		DN100 x DN50	PN16
DN125 x DN40		DN100 x DN40	PN16
DN125 x DN50		DN100 x DN50	PN16
DN150 x DN40		DN150 x DN40	PN16
DN150 x DN50		DN150 x DN50	PN16
DN150 x DN80		DN150 x DN80	PN16
DN150 x DN100		DN150 x DN100	PN16
DN200 x DN40		DN200 x DN40	PN16
DN200 x DN50		DN200 x DN50	PN16
DN200 x DN80		DN200 x DN80	PN16
DN200 x DN100		DN200 x DN100	PN16
DN250 x DN50		DN250 x DN50	PN16
DN250 x DN80		DN250 x DN80	PN16
DN250 x DN100		DN250 x DN100	PN16
DN300 x DN50		DN300 x DN50	PN16
DN300 x DN80		DN300 x DN80	PN16
DN300 x DN100		DN300 x DN100	PN16
DN350 x DN80		DN300 x DN80	PN16

View and insertion point

Insertion point: Point 1

System: Supply

Start element: --

End element: --

Insert reducer

Repeat command

Current unit: millimetres

Object style: [icon] OK

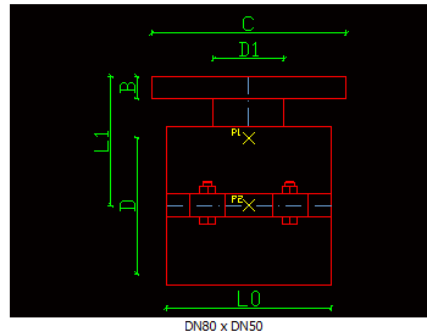



CADprofi

✓ CADprofi HVAC & Piping – extension of the outlets command

Outlets command has been extended with SMAY company outlets and Maico Ventilatoren roof blowers.



Name	D	Capacity	Manufac
Slotted outlet 3			
600	160.0	270	
750	160.0	306	
900	160.0	342	
1050	160.0	378	
1200	160.0	414	
1350	160.0	432	
1500	160.0	468	
1650	160.0	558	
1800	160.0	594	
1950	160.0	612	
Smay			
NSW			
NSW-N-3-800/S3I-2-160	200.0		Smay
NSW-N-3-1000/S3I-2-160	200.0		Smay
NSW-N-3-1500/S3I-2-160	200.0		Smay
NSW-N-3-2000/S3I-2-160	200.0		Smay

Name	L
NSW-N-3-1500/S3I-2-160	1500
NSW-N-3-1500/S3I-2-160	1500

Spacing: 3000

View and insertion point: 2D, System, Supply air, Article: NSW-N-3-1500/S3I-2-160, Manufacturer: Smay, Capacity [m3/h], Flow [m3/h].

Current unit: millimetres. Object style: Insert from list.

✓ New Dahua library

New library available in CADprofi program contains Dahua Electric products, including:

- Network Recorders.
- IP Cameras.
- Network Keyboards.
- Monitors.
- Switches.
- VDP products (apartment, modular, monitors, accessories).

Library also contains VDP Dahua schemes.

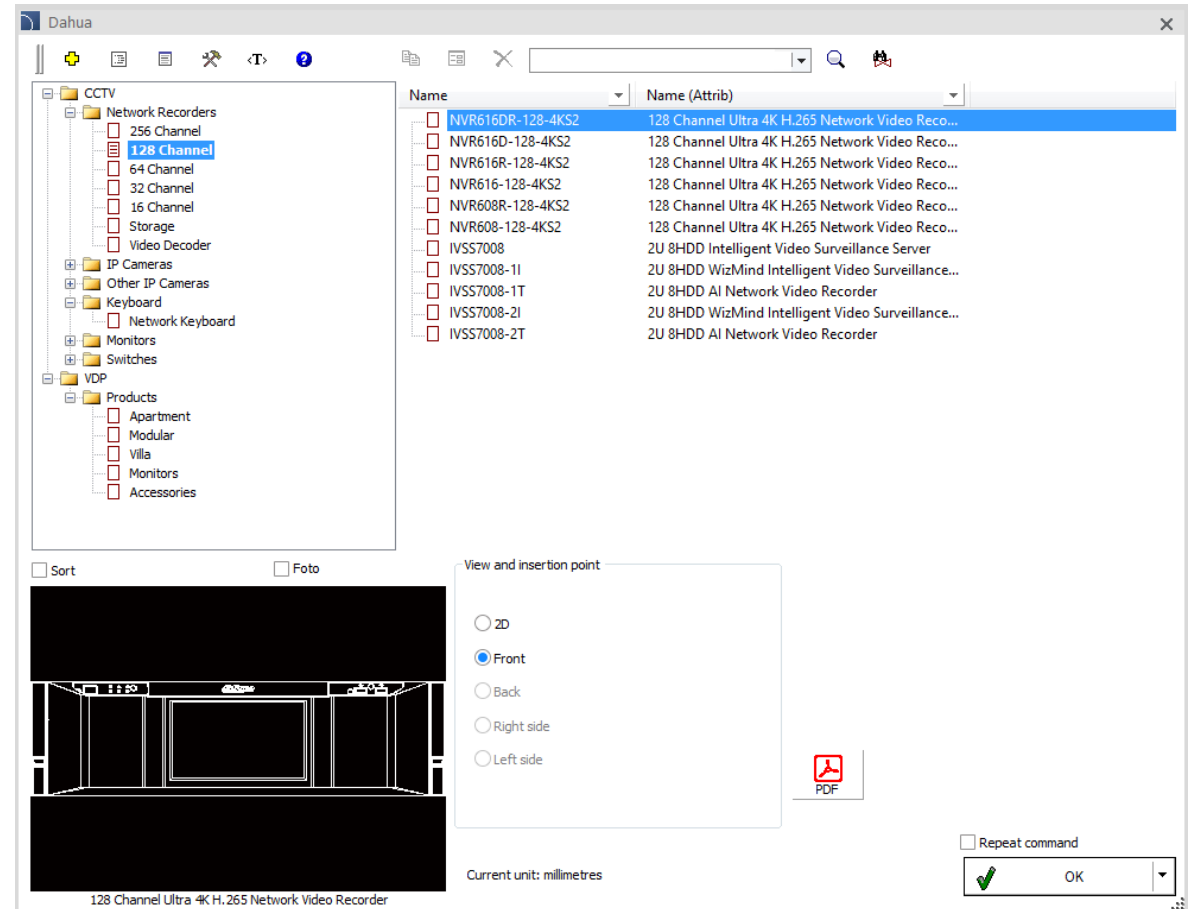

✓ New Relpol library

New library available in CADprofi program contains Relpol Electric products, including:

- Miniature, industrial, installation, interface, railroad, programmable, time and monitoring relays.
- Signal lamps.
- Contactors.
- Softstarters.
- Power supplies.
- Overvoltage arresters.

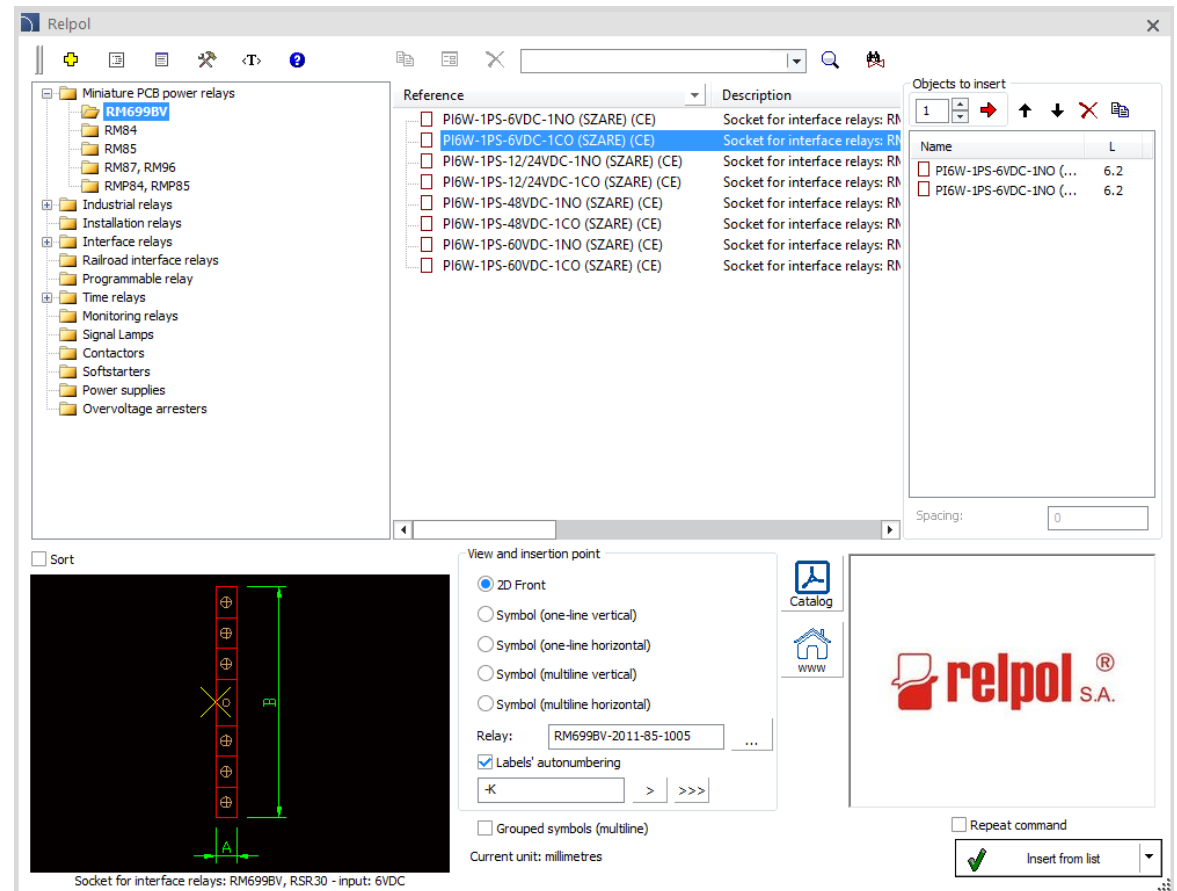
Reference

Reference	Description
<input type="checkbox"/> PI6W-1PS-6VDC-1NO (SZARE) (CE)	Socket for interface relays: RM
<input checked="" type="checkbox"/> PI6W-1PS-6VDC-1CO (SZARE) (CE)	Socket for interface relays: RM
<input type="checkbox"/> PI6W-1PS-12/24VDC-1NO (SZARE) (CE)	Socket for interface relays: RM
<input type="checkbox"/> PI6W-1PS-12/24VDC-1CO (SZARE) (CE)	Socket for interface relays: RM
<input type="checkbox"/> PI6W-1PS-48VDC-1NO (SZARE) (CE)	Socket for interface relays: RM
<input type="checkbox"/> PI6W-1PS-48VDC-1CO (SZARE) (CE)	Socket for interface relays: RM
<input type="checkbox"/> PI6W-1PS-60VDC-1NO (SZARE) (CE)	Socket for interface relays: RM
<input type="checkbox"/> PI6W-1PS-60VDC-1CO (SZARE) (CE)	Socket for interface relays: RM

Objects to insert

Name	L
<input type="checkbox"/> PI6W-1PS-6VDC-1NO (...)	6.2
<input checked="" type="checkbox"/> PI6W-1PS-6VDC-1NO (...)	6.2

Spacing: 0

Sort

View and insertion point

2D Front

Symbol (one-line vertical)

Symbol (one-line horizontal)

Symbol (multiline vertical)

Symbol (multiline horizontal)

Relay: RM699BV-2011-85-1005

Labels' autonumbering

Grouped symbols (multiline)

Current unit: millimetres

Repeat command

Insert from list

Socket for interface relays: RM699BV, RSR30 - input: 6VDC

✓ New Siemens library

New library available in CADprofi program contains Siemens products, including:

- Miniature circuit breakers.
- RCBOs
- Residual current operated circuit breakers.
- RCD add-on blocks.
- Selective main circuit breakers.
- AFDD Arc fault detection devices.
- Lightning surge arresters.
- 5TL1 On/Off switches.
- 5TE1/5TE2 switch disconnectors.
- Switch disconnectors.
- Motor protective circuit breakers.
- Contactors

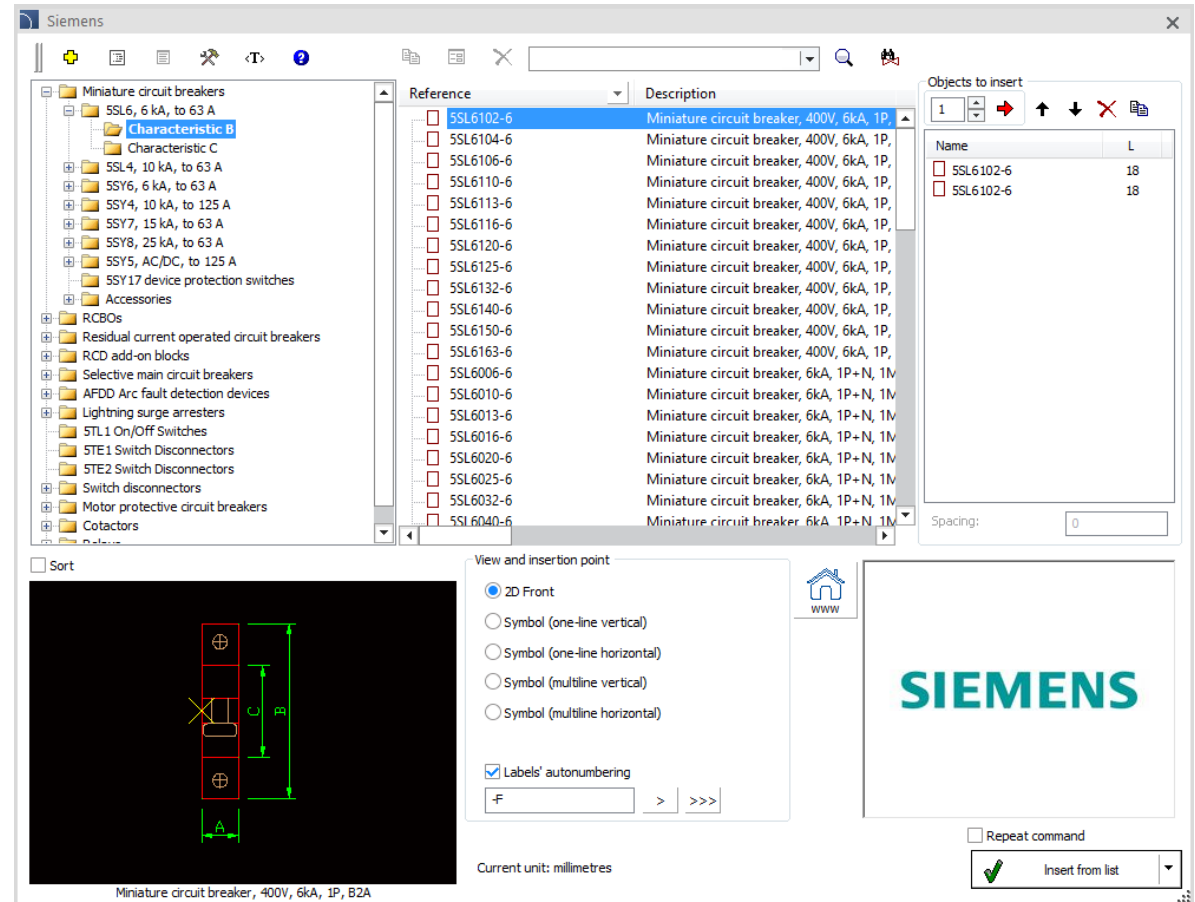
The screenshot displays the Siemens library window in CADprofi. It features a tree view on the left showing categories like 'Miniature circuit breakers', 'RCBOs', and 'Residual current operated circuit breakers'. The main area shows a list of circuit breaker models (e.g., 5SL6102-6, 5SL6104-6) with their descriptions. A 2D front view of a miniature circuit breaker is shown at the bottom left, with dimensions A, B, C, and R indicated. The Siemens logo is prominently displayed in the bottom right corner of the interface.

Reference	Description
5SL6102-6	Miniature circuit breaker, 400V, 6kA, 1P
5SL6104-6	Miniature circuit breaker, 400V, 6kA, 1P
5SL6106-6	Miniature circuit breaker, 400V, 6kA, 1P
5SL6110-6	Miniature circuit breaker, 400V, 6kA, 1P
5SL6113-6	Miniature circuit breaker, 400V, 6kA, 1P
5SL6116-6	Miniature circuit breaker, 400V, 6kA, 1P
5SL6120-6	Miniature circuit breaker, 400V, 6kA, 1P
5SL6125-6	Miniature circuit breaker, 400V, 6kA, 1P
5SL6132-6	Miniature circuit breaker, 400V, 6kA, 1P
5SL6140-6	Miniature circuit breaker, 400V, 6kA, 1P
5SL6150-6	Miniature circuit breaker, 400V, 6kA, 1P
5SL6163-6	Miniature circuit breaker, 400V, 6kA, 1P
5SL6006-6	Miniature circuit breaker, 6kA, 1P+N, 1N
5SL6010-6	Miniature circuit breaker, 6kA, 1P+N, 1N
5SL6013-6	Miniature circuit breaker, 6kA, 1P+N, 1N
5SL6016-6	Miniature circuit breaker, 6kA, 1P+N, 1N
5SL6020-6	Miniature circuit breaker, 6kA, 1P+N, 1N
5SL6025-6	Miniature circuit breaker, 6kA, 1P+N, 1N
5SL6032-6	Miniature circuit breaker, 6kA, 1P+N, 1N
5SL6040-6	Miniature circuit breaker, 6kA, 1P+N, 1N

✓ New Schrack Technik library

New library available in CADprofi program contains Schrack Technik products, including

- Miniature and residual circuit breakers.
- Arc fault detection devices.
- RCBO Combined MCB and RCCB
- AFDD Arc Fault Detection Devices
- Selective main circuit breakers
- Tariff switches
- Surge protective devices
- On-Off and main load-break switches
- Fuse switch-disconnectors.
- Motor-protective circuit-breakers.
- Relays
- PLC series EASY
- Soft starters
- Control and signalling
- Load switches.
- Soft starters.
- Control and signalling.
- Load switches.
- Circuit and air circuit breakers.
- Switch disconnectors.

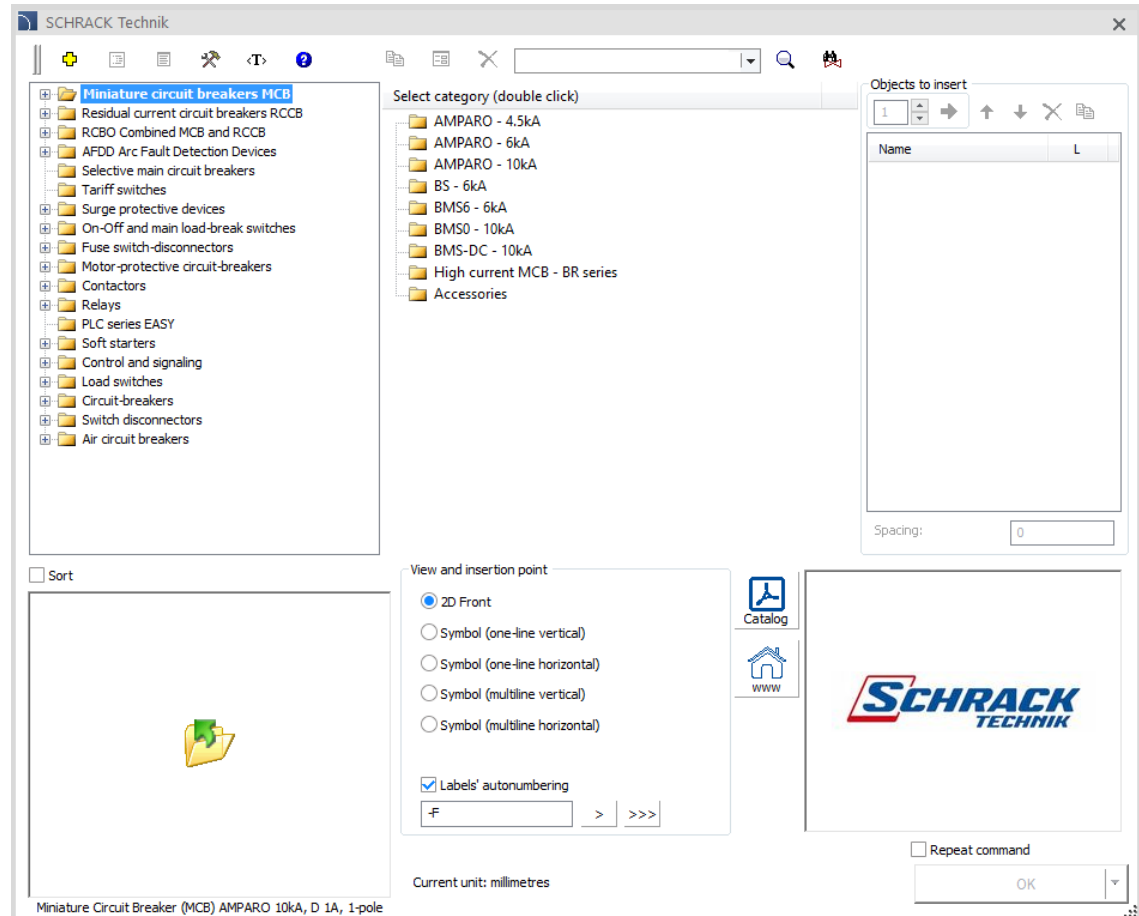

✓ New NOARK Electric library

New library available in CADprofi program contains NOARK Electric products, including:

- Miniature and residual circuit breakers.
- RCD add-on blocks.
- Surge protection devices.
- Isolators.
- Motor protective circuit breakers.
- Contactors.
- Relays.
- Energy meters and CT's.
- Control and signalling.
- Moulded case and air circuit breakers and disconnectors.

NOARK

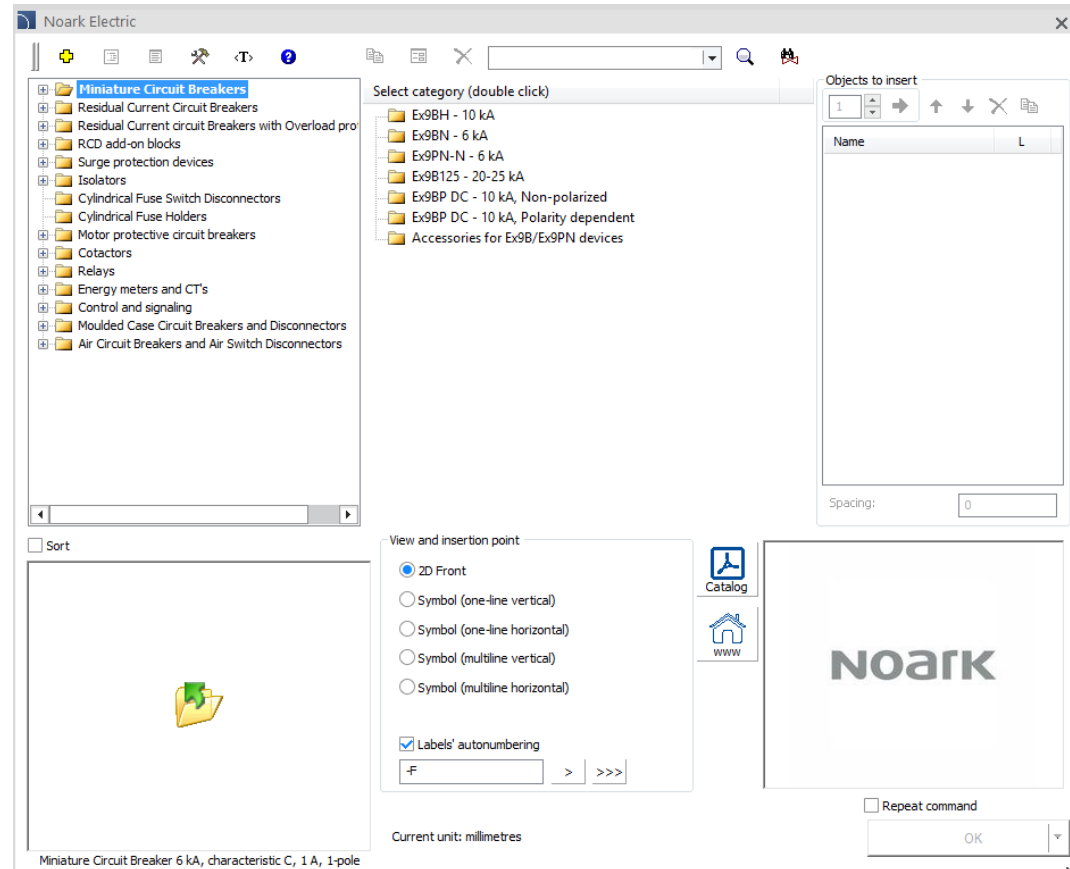



CADprofi

✓ ABB library extension – low voltage AC drives

The ABB library available in CADprofi has been extended with low voltage AC drives (industrial drives, drives for water, drives for HVAC).



The screenshot displays the CADprofi software interface with the ABB library extension for low voltage AC drives. The interface is divided into several sections:

- Left Panel (Tree View):** Shows a hierarchical structure of ABB products. The 'Low voltage AC drives' folder is expanded, showing sub-folders for 'Industrial drives', 'Drives for water', and 'Drives for HVAC'. The 'Industrial drives' folder is further expanded to show 'Wall-mounted single drives', which includes the 'ACS580-01' drive.
- Center Panel (Table):** A table listing the 'ACS580-01' drive with various characteristics. The table has columns for 'Name' and 'Characteristics'. The 'Characteristics' column lists 'Wall-mounted drives, frame size R1' through 'R8'.
- Right Panel (Objects to insert):** A panel for inserting objects into the drawing. It includes a 'Name' field, a 'Spacing' field (set to 0), and a 'Repeat command' checkbox.
- Bottom Panel (View and insertion point):** A panel for configuring the view and insertion point. It includes a 'View and insertion point' section with radio buttons for '2D Front', 'Symbol (one-line vertical)', 'Symbol (one-line horizontal)', 'Symbol (multiline vertical)', and 'Symbol (multiline horizontal)'. There is also a 'Labels' autonumbering checkbox and a field for the label text (set to '-T').
- Bottom Right Panel:** A panel for the 'Cabinet' object, showing a 3D model of the drive and a 'Repeat command' checkbox.

The current unit is set to millimetres. The 'OK' button is highlighted with a green checkmark.

✓ Update of Hager library

Hager library has been updated with:

- a new product tree structure that is more intuitive and speeds up device search,
- the latest series of devices with the QuickConnect system,
- an extended library of KNX system building automation products,
- the latest Hager Lumina products.

This library is available in Poland and Ukraine region.

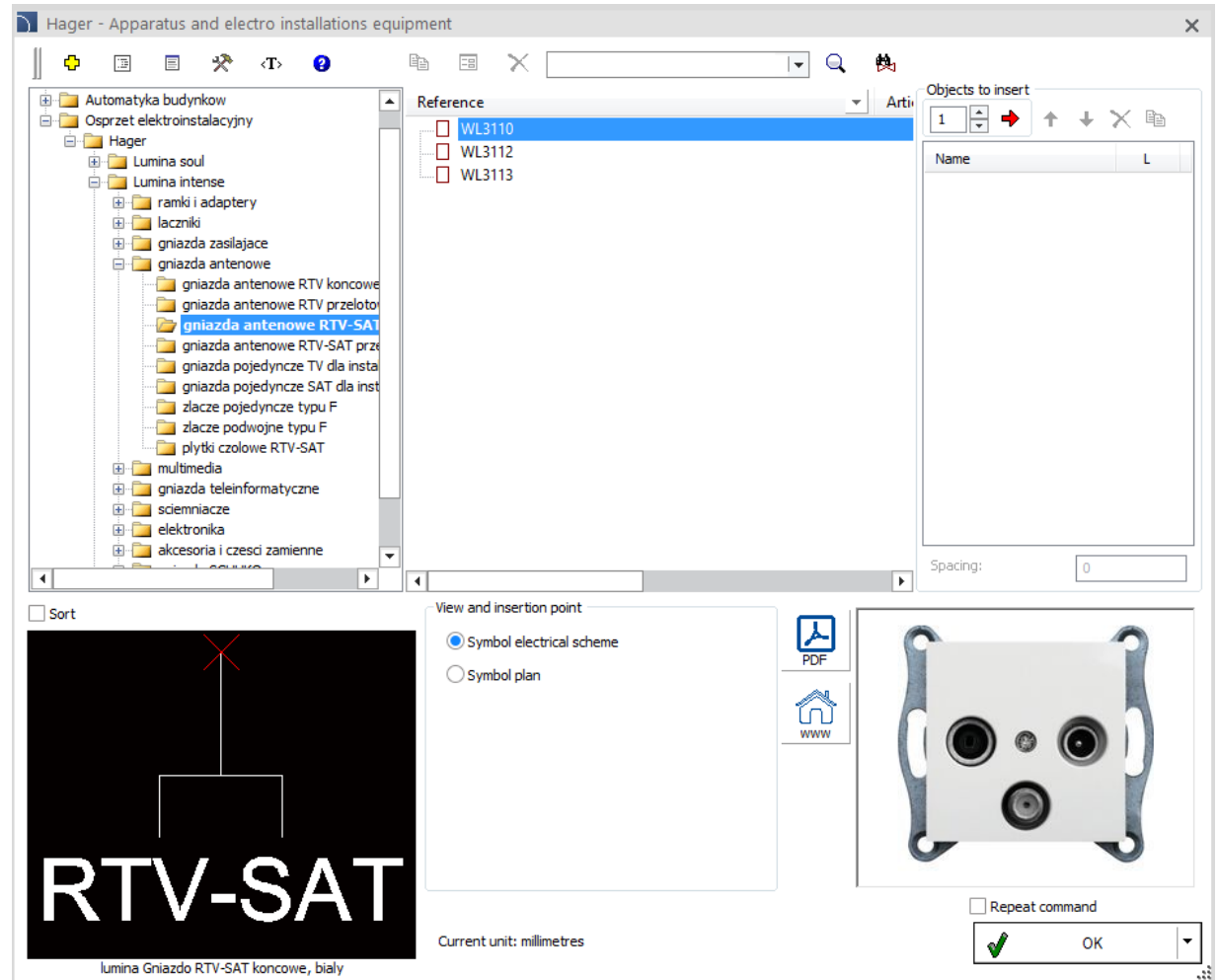

✓ KaMo – product update and a new boiler room schematic generator

In the boiler room diagram generator, new systems use the universal Combi Control regulator. In the generator, user can select a specific system of buffers (1, 2 or 3 buffers connected in series or in the Tichelmann system). It is also possible to define the number of heating circuits with the selection of the desired pump groups.

A complete set of new housing stations for decentralized hot water preparation has also been introduced to the KaMo library.

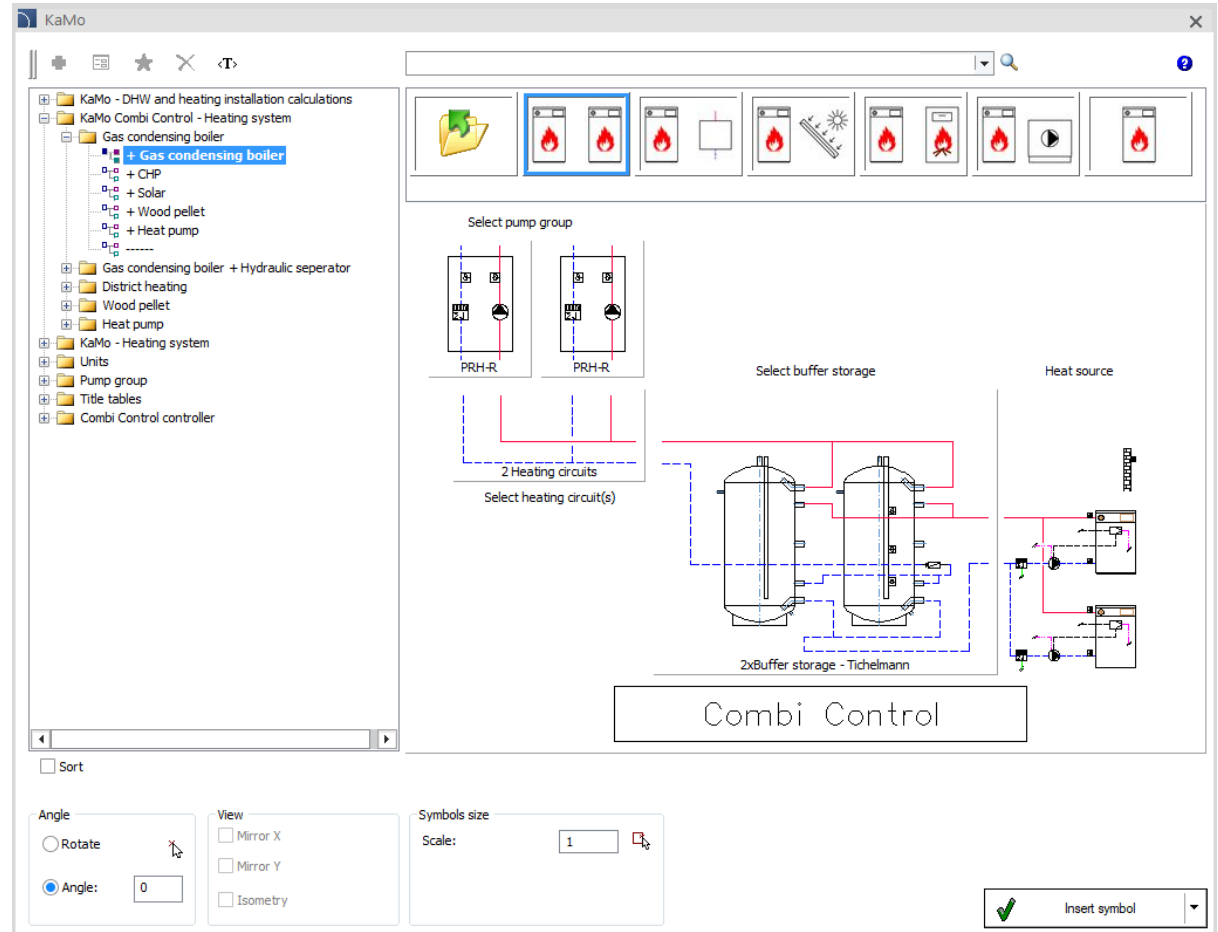

The main window that allows user to conveniently define any scheme



CADprofi

✓ Update of manufacturers' libraries:





CADprofi

✓ Adjustment to many base CAD programs

CADprofi 2021 has been adjusted to work with latest CAD programs, including: 4MCAD 21, ActCAD 2020 – 2021 (x64), AutoCAD 2021, ArCADia 12, Ares Commander 2020, BricsCAD 2021, CMS IntelliCAD 9.2 (x64), GstarCAD 2021, INTERsoft IntelliCAD 2020, progeCAD 2021, ZWCAD 2021.

CADprofi 2021 currently works with many base CAD programs including: AutoCAD (since the 2000 version), BricsCAD, GstarCAD, IntelliCAD, progeCAD, ZWCAD, ARES Commander Edition and others.

The logo for AutoCAD, with the word "AutoCAD" in a bold, red, sans-serif font.

The logo for ZWCAD, with the word "ZWCAD" in a bold, blue, sans-serif font, featuring a green leaf-like graphic above the 'W'.

The logo for GstarCAD, with "Gstar" in blue and "CAD" in yellow, followed by the tagline "An Alternative CAD System" in blue.

The logo for BricsCAD, featuring a stylized blue 'B' shape above the word "BRICSCAD" in a bold, blue, sans-serif font.

The logo for progeSOFT, featuring a blue globe with a yellow 'I' shape inside, above the word "progeSOFT" in a blue, sans-serif font.

The logo for IntelliCAD, featuring a purple diamond shape with a yellow 'I' shape inside, above the word "IntelliCAD" in a bold, purple, sans-serif font.

The logo for Gräbert ARES Commander, featuring a red, flame-like graphic above the word "Gräbert" in a small font, and "ARES® Commander" in a large, bold, black font.